

FLUID THERAPY IN ACUTE LARGE AREA BURNS:
A SYSTEM DYNAMICS ANALYSIS

Bush, James W. [1], Schneider, Alan M. [2], Wachtel, Thomas L. [3],
and Brimm, John E. [4]

Departments of Community and Family Medicine [1], Applied
Mechanics and Engineering Sciences [2], Surgery [3], and Pathology [4]
University of California, San Diego, La Jolla, CA 92093

Running Head: Burn Fluid Therapy

Key Words: computer simulation, mathematical models, System Dynamics,
systems science, acute burns, extracellular water, renal output, homeo-
stasis, dehydration, Brooke formula, control theory, fluid balance, shock,
resuscitation, blood volume, hemoconcentration, plasma, electrolytes

To be presented at the International Conference on System Dynamics
Newton, Massachusetts
July 1983

Acknowledgements: We wish to thank Dr. Robert Zeldin for helpful
discussions during the early model formulation, Professors Ed
Roberts, Jay Forrester, and the Sloan School of Management, for
their hospitalilty and support during the first author's sabbati-
cal at MIT, the Dean's Office, school of Medicine, University of
California, San Diego, for initial financial support, Rosemary
Buerger, Jane Chamberlin and Suzanne Burns for secretarial assis-
tance, Ester McConnell and Michelle Harden for research and li-
brary assistance, Ray Madachy and David Whiteman for computer
programming, and the UCSD Computer Center for processor time and
software support.

ABSTRACT

A preliminary mathematical model of fluid dynamics in acute
large area burns presently incorporates plasma water, urine out-
put, burn water loss, insensible losses via the non-burned skin,
lungs, and G-I tract, as well as inputs of maintenance water and
therapeutic (Brooke Formula) fluids. The model is an initial step
in a longer-term project to identify the pathogenetic mechanisms
that control fluid shifts and to evaluate the effects of crystal-
loid (sodium ion), colloid (albumin), and other guidelines for
fluid resuscitation. The model is initialized in homeodynamic
equilibrium for a standard 70 KG person, and gives reasonable,
realistic responses to a wide range of parameter variations (body
sizes, burn wound loss factors), step functions (burn size,
discontinuation of maintenance water), and rates of therapeutic
fluid administration, given its present structure. The addition
of burn and nonburn interstitial and intracellular spaces and
their constituents (water, sodium, albumin and potassium) will:
1) permit validation against a wide body of clinical and experi-
mental data, 2) suggest refinements of current resuscitation
guidelines, 3) suggest more incisive research on pathogenetic
mechanisms and treatment modalities, and 4) permit comparison of
System Dynamics with alternative modeling and simulation
approaches.

FLUID THERAPY IN ACUTE LARGE AREA BURNS:

A SYSTEM DYNAMICS ANALYSIS

INTRODUCTION (1.0)

BACKGROUND (1.1)

System Dynamics has been applied to several biomedical problems in the past [1-5]. In addition, a rapidly increasing number of standard engineering and control theory simulations are being constructed for pathophysiological processes [6-20].

Because of the large volume of clinical and experimental data available, and because of the short time constants in physiological as compared to corporate, social, and economic systems, studies of pathophysiology with System Dynamics have the methodological merit of affording a direct contrast with alternative approaches to model formulation, analysis, use, and validation.

Most physiological models have been formulated help identify physiological organ systems, rather than to precisely characterize pathological states and improve their clinical management. Many have been done as illustrative teaching exercises.

DYNAMIC PROBLEM (1.2)

Fluid therapy in acute burns offers an opportunity to study a relatively frequent clinical problem of short duration involv-

ing several organ systems that can be used to compare System Dynamics with more orthodox analyses. The problem has received more quantitative attention than many clinical medical problems [21-34], but only limited attention from control theorists. That effort, since abandoned, tried to use an empirically determined canine transfer function to guide microprocessor control of infusion [35].

Patients burned over a large portion of their body immediately begin to lose large amounts of plasma water, protein, sodium and potassium from the wound. This is initially replenished from the interstitial fluid that occupies the space between the cells of the body, especially in the muscles and skin.

As the breakdown products from the burn wound circulate throughout the vascular system, a generalized inflammatory response is initiated that increases the permeability of capillary membrane throughout most of the normal tissues so that the circulating plasma protein (albumin) escapes into the interstitial space.

Because proteins maintain the intravascular osmotic pressure, their loss into the interstitial fluid slows or even halts the replenishment of the circulating plasma volume. This loss of circulating blood volume produces hypovolemic shock, depresses cardiac and kidney output, decreases tissue perfusion, increases acidosis, and eventually kills the patients.

The treatment involves replacing the continuing losses of

water, sodium (crystalloid), and albumin (colloid), at a rate that will maintain urine output and fill up the interstitial space so the blood volume can also be maintained.

A very real danger exists, however, especially in older and younger patients, that an overshoot will occur in the fluid loads given and the patient will die from cardiac failure or pulmonary edema (fluid in the lungs). Several days postburn, with decreases in various stress hormones, the kidneys begin excreting voluminous urine output until the stored water is pulled down to near normal levels.

Discovery of the dramatic effects of fluid therapy during and immediately following the Korean War was a major breakthrough in burn resuscitation. The use and optimal rates of administration of the different components of the fluids has continued to be a source of controversy, however, despite three decades of progressive understanding of the basic physiology based on animal as well as clinical research.

The issue concerning colloid is whether (expensive) plasma proteins are of value in therapy, or whether they are useless in fluid management because of the 26 to 30 hour increase in capillary permeability and perhaps eventually harmful because they increase the viscosity of the interstitial gel and retard healing [36].

This problem seemed worthy of attention from System Dynamics.

METHODS (2.0)

Our methods include the construction of the model, analysis of the responses to step functions, sensitivity analyses of its parameters, and analyses of responses to standard treatments. Comparisons with known relationships, experimental data, and responses to treatment will be made at several points.

MODEL CONSTRUCTION (2.1)

To initialize the model in equilibrium, we adopt the parameters of a 70KG person -- a standard reference case in physiology. Our model represents the forces implicit in normal physiology. A burn is then imposed on the patient, followed by alternative treatments.

The model is generalized to persons of all sizes and shapes by defining a weight ratio WGHTR to the standard person. Although linear, this formula refines the usual clinical rules where adult averages are used rather than precise calculations.

Using the patient's known height and weight, standard formulas estimate the body surface area, blood volume, red cell mass, and plasma water volume. Rate equations are usually related either to body surface area or to lean body mass, which is more closely related to height than to recorded weight.

In equilibrium, maintenance water comes in by mouth or by vein IVWM, and escapes via insensible losses INS, which sums losses from separate rates for the skin, lungs, and the

gastrointestinal tract. These rates are affected only by the level of plasma water itself.

Water is also lost by urinary excretion UX, which responds to the plasma water through the blood volume consisting of a fixed volume of red cells RC and the plasma. Variations in the blood volume BV presently reflect only changes in plasma water. Urine excretion at any time is equivalent to the normal urine excretion UXN modified by the current level of plasma water PW by a multiplier UMBV that summarizes the renal response to blood volume.

The rate of water loss via the burn wound BWL is set as a multiplier BWLM of the normal unit skin water loss SWLFN. This rate is further modified by the size of the burn area BA, the plasma water ratio PWR, and a control variable BURN for the presence or absence of a burn.

Another rate represents maintenance water IVWM controlled exogenously at water cutoff and turnon times MWCOTM and MWTOTM. An "accounting" level IVWTT sums the total water given from all sources after the time of the burn BRNTM, but does not interact in any feedback processes.

Normal flow rates at equilibrium for the 70 KG person are transformed to proportional flow rates for persons of other weights. Equilibrium flow rates of 1500 ML per day for normal urinary excretion UXN, 500 ML per day for total skin water loss at SWLTQ, and 500 ML per day for lung and GI loss LWL all combine

to produce a maintenance water requirement IVWM of 2500 ML per day for the standard person.

These equilibrium values generate average hourly flow rates for urine excretion UX of 63 ML per hour, lung and GI losses LWL of 21 ML per hour, and normal skin water losses SWL of 21 ML per hour. The blood volume ratio BVR and the plasma water ratio PWR relate the current values to the equilibrium values for persons of that height and weight.

Initial inputs to the model are of three forms: 1) characteristics of the patient such as height HTIN, weight WTN, and burn size BSAB, 2) constants that cannot be derived from the equilibrium conditions, such as the burn water loss multiplier BWLM, and 3) settings for control switches that represent water inputs, the time of the burn, and the time of treatment.

TEST FUNCTIONS (2.2)

The preliminary analyses reported here contrast several aspects of different treatments, as follows:

- 1) Continuation in equilibrium vs. discontinuation of maintenance water in the unburned person, a step representing total fluid deprivation.
- 2) Continuation vs. discontinuation of maintenance water in the burned patient, testing the model's emulation of no treatment vs. low-level, inadequate treatment, and

- 3) The institution of the Brooke formula at 4 and at 8 hours respectively, with no fluid from burn time BRNTM until treatment time RXTM.

These fundamental fluid variations are emulated in the standard 70 KG person with 10, 40, and 80% burns. The present model permits us to examine the response of the renal-cardiovascular complex to a burn without the physiological (but clinically confounding) effects of the interstitial "third space" reservoir.

SENSITIVITY ANALYSIS (2.3)

Minimum tests for sensitivity include high and low values for each important factor around a baseline case. The possible combinations of parameter values grow exponentially with the number of variables being studied, as well as the number of levels taken of each variable, so a comprehensive analysis quickly becomes intractable.

One shortcut is "extreme" or "worst case" analysis, in which all the extreme (high or low) values are taken together simultaneously. If the model behaves appropriately at such extremes, then the assumption of appropriate behavior at intermediate values of the system variables is much more strongly assured.

In the burn case, for example, we can combine all the factors with bad prognoses currently in the model, e.g. a small patient, a big burn, a large coefficient for burn water loss, and delayed treatment as a "worst case". If the model produces good

outcomes, or bad outcomes too quickly, then the model has been falsified in some respect and we must refine the previous effort.

TREATMENT SELECTION (2.4)

The appropriate clinical response to complex problems like fluid therapy is a sophisticated blend of multiple rules, based on qualitative knowledge of the underlying process, but most heavily on the responses of previously observed and reported patients.

All our decision rules can be tested individually, in combination with each other, and with different conditions of the patient (settings of the uncontrollable variables). This permits us to evaluate the therapeutic response, unanticipated side effects, and most importantly, appropriate timing to avoid iatrogenic (physician induced) undershoots and overshoots.

Prescribed water RXW is represented by a level that is filled with the fluid calculated for the first forty-eight hours. The level of treatment water RXW is presently prescribed by the BROOKE formula calculated from the normal weight WTN and body surface area burned BSAB.

Its infusion RXW2IV is controlled by the amount of prescribed water remaining and the IV treatment water time IVRXWT. The present model does not alter the prescribed input by any information on the patient's state.

In sensitivity analysis we adopt the model structure and parameter values that best reproduce known behavior. In treatment selection, we choose those rules or treatment variable coefficients that produce the closest approximation of our desired outcomes, i.e., survival, restored homeostasis, and improved quality of life.

Present burn treatment formulas do not constitute rules of this form. They represent, instead, the aggregated results of the hour-to-hour feedback from hundreds of previous patients. In complex systems, this well-formulated experience aids in tracking the patient by anticipating the course of therapy, and permits the derivation of more sensitive and refined treatment rules.

This derivation of treatment rules involves making explicit the previously implicit moment-to-moment guides used for online therapy. In medicine, where data on treated patients are more common than data on untreated, known responses to alternative treatments also provide additional tests of validity.

Practically speaking, truly optimal therapies do not exist. Multiple therapeutic approaches may be equivalently good (or bad), and the compensations induced by the underlying physiological feedback structure may cancel out the advantage of one therapy over an alternative. Whether this indeterminacy accounts for enduring dilemmas about colloid vs. crystalloid, or hypotonic vs. hypertonic sodium solutions, remains to be investigated.

Although intuition and formal analysis can eliminate some

treatment combinations from consideration, we must eventually resort to strategies such as extreme case analysis to extract general guidelines. We plan to formulate and evaluate sets of feedback rules without, as well as with, existing formulas.

The preliminary model reported here includes the Brooke formula without regard to information about the patient's state; this open-loop analysis -- although clinically unrealistic -- is a helpful concept in model identification. As with all uncoupling of system structure, analysis of the resulting behavior frequently clarifies the effects in the patient where the system is actually coupled.

RESULTS (3.0)

The following sections present the salient features of the model and its response to several test functions. Note that the time scale is compressed after TIME = 30 to preserve detail initially while displaying longer term outcomes on the same graph. The results of the computations for different size persons are generally reasonable but are not tabulated for this paper.

Results of Case 1: Long-Term Water Deprivation

An initial test of the validity of the model is a negative step function that drops maintenance water IVWM from equilibrium levels to zero with no subsequent rise. The patient has no burn and receives no treatment. The plasma water PW falls gradually over the ensuing 48 hours, the plasma water ratio PWR reaching approximately 50% of its normal value at 30 hours.

By that time, urine excretion UX has declined to less than 10 ML per hour (and normal skin water loss SWL has also declined markedly) with the hematocrit HCT rising to .57. These trends continue to almost universally fatal levels by about four days, which approximates our understanding of the clinical situation.

Results of Case 2: Short-Term (30 Hour) Water Deprivation

Case 2 also discontinues maintenance water IVWM at time zero, but restores IVWM at 30 hours with no burn and no other treatment. The plasma water PW is lost initially at the same rate as in the previous case.

When maintenance water IVWM is restored (perhaps by mouth) at 30 hours, however, the multiplier for the effects of blood volume UMBV continues to reflect the low plasma water volume and inhibits urinary excretion. The plasma water PW, and its associated auxiliaries and rates, such as hematocrit HCT, urinary output UX, skin water loss SWL, and blood volume BV, all return almost to normal over the next 24 hours, with virtually complete equilibration by 60 hours.

This case demonstrates the smooth and appropriate operation of the renal excretion multiplier UMBV, which summarizes the action of multiple hydrostatic, osmotic, and hormonal fluid retention and release mechanisms, without the addition of therapeutic fluids.

Results of Case 3: 40% Burn with No Treatment

With all the parameters set for the same equilibrium, a burn at time zero is simulated by a step in the burn water loss multiplier BWLM to 20 times the normal skin water loss, where it remains for the duration of the run. This "parameter excitation" activates the burn water loss rate BWR, which is set at the outset for a 40% burn.

The water loss from the burn BWL therefore steps to approximately 100 ML per hour initially and then declines gradually as plasma water PW decreases. The sensitivity of the model to that function is examined below.

The plasma water ratio reaches 50% of its normal value in about 12 hours; which corresponds closely to the clinical course of the patients. By that time, urine excretion UX has declined below 10 ML per hour and the hematocrit has risen to 55.

Skin, lung and GI water loss, along with the blood volume, fall accordingly. If mortality were 50% with a 50% loss of plasma, then at least half the patients would die before 12 hours and almost all would die within 24.

Results of Case 4 (Base): 40% Burn with BROOKE Treatment

This case -- the baseline for all further tests -- begins with all the previous equilibrium conditions, including the changes induced by a 40% body surface area burn BSAB. In addition, treatment is initiated at treatment time RXTM 4 hours postburn by the prescription RXW of the Brooke formula for 48 hours. This is administered at an initially high but decreasing rate RXW2IV corresponding to the formula and to common clinical practice.

The Brooke formula includes the maintenance water to be administered over the 48-hour postburn period. The plots demonstrate the initially declining plasma water PW, urine excretion UX, and burn water loss BWL, and the rising hematocrit HCT, just as in the untreated Case 3.

In this instance, however, intravenous water RXW2IV is given rapidly beginning at 4 hours postburn (RXTM = 4). The plasma water, urine output, and blood volume respond immediately with a

substantial overshoot of equilibrium in all three variables, with the plasma water ratio PWR rising to almost 1.6 times normal.

This overshoot -- an unphysiologic response that is not usually observed clinically -- reflects the unusually high IV infusion rate and especially the absence of an interstitial space (in the present model) to absorb the water.

Despite the overshoot, the continuing burn water loss BWL pulls the plasma water PW and the blood volume BV back to near-equilibrium levels at 34 hours. The burn water loss BWL continues until the patient again becomes severely dehydrated by about 48 hours. The ensuing course up to 5 days postburn demonstrates that restoring maintenance water IWWM alone, after exhausting the Brooke formula, is insufficient to replace the ongoing burn water loss BWL.

In clinical practice, the continuing losses would usually be met by the oral intake of the patient, governed by thirst, which is not represented in the current model. Given the specified structure, however, the response is realistic.

Results of Cases 5, 6: Sensitivity Analysis of Burn Water Loss Multiplier BWLM

Cases 5 and 6 show the sensitivity of different values of the burn water loss multiplier (BWLM = 5 and 20). Despite previous measurements [37,38], the precise value of this factor for the water loss per unit area is uncertain, and measurement results have varied over a wide range. These sensitivity tests

are both in a 70 KG person with the 40% ("standard") large area burn.

For BWLM = 5, dehydration and hemoconcentration do not develop as rapidly. Because the high volume of the Brooke formula is computed in exactly the same way, however, the plasma water ratio PWR rises to even higher, more unphysiologic levels than in base case 4. Similarly, urine excretion UX rises much higher, and the hematocrit falls slightly lower than in the reference case.

Water loss from the wound BWL also lags substantially behind the reference case, but still varies by a factor of 2, reflecting hydrostatic pressure from the plasma water level PW. As in the base case, the combined water losses gradually exceed the formula input and the patient becomes dehydrated again before maintenance water IVWM is restored at 48 hours. A new equilibrium is then established with the plasma water ratio at a slightly lower level (PWR = .86) than in the base case and with a decreased but clinically sufficient urine excretion (UX = 41 ML/HR).

Case 6 is identical to the base Case 4 and Case 5 except for the increase of the burn water loss multiplier BWLM to 20 times the normal skin water loss SWLFN. As expected, it shows a much higher rate of burn water loss over the 48 hour resuscitation period.

The burn wound still demonstrates markedly varying hour to hour water loss, however, even though the burn water loss multi-

plier BWLM is constant for a given burn. The marked variation directly reflects the changing pressure from plasma water volume PW as the patient first becomes dehydrated, then overinfused, then dehydrated again.

The plots show a new equilibrium with plasma water at approximately 50% of normal, which is only marginally compatible with life. In the clinical situation, the patient would probably be on oral fluids ingesting much larger than maintenance volumes, or such volumes would be administered intravenously. Revisions of the model will correct these deficiencies.

These two runs demonstrate fundamentally the same pattern of dehydration, overcompensation, decline to below maintenance, and restoration to a new (perhaps unphysiologic) equilibrium. Although the burn water loss multiplier BWLM was varied by a factor of 4, the change in the pattern of the model behavior was modest.

Results of Cases 7, 8: Sensitivity Analysis for Burn Size BSAB

Cases 7 and 8 display the model response to small and extremely large body surface area burns (BSAB = .1 and .8). The burn water loss multiplier BWLM is reset at 10 times normal skin loss, as in the base case.

In Case 7, with a body surface area burn BSAB of only 10%, the burn water loss BWL is much lower than in previous cases. Other curves show the same fundamental pattern but with much narrower excursions. The plasma water rises only slightly above

equilibrium, since the Brooke formula prescribes a lower volume for a smaller burn. Plasma water PW again descends to dehydration levels after 30 hours, and recovers only to a diminished equilibrium, since wound water losses continue even after maintenance water is restored at 48 hours (MWTOTM = 48).

With an 80% burn (Case 8), the initial dehydration (and hemoconcentration) progress more rapidly and then respond more dramatically to the much larger volumes of prescribed fluid RXW. Despite the huge volumes of fluid -- over 18 liters -- the plasma water ratio PWR again falls below equilibrium by 36 hours.

Because of continuing high burn water losses, the resumption of maintenance water IVWM brings the plasma water up to only 1/3 of its initial equilibrium level. This is insufficient to sustain life.

Despite an eightfold variation in the burn size BSAB and a fourfold variation in the initial volumes of prescribed fluid RXW, the same basic response pattern recurs. The feedback between plasma water volume PW and the loss of the water through the urine, the burn wound, and insensible losses explain the persistence of the pattern: lower volumes (with lower pressures) decrease, while higher volumes accelerate, fluid excretion.

These forces tend to balance as the Brooke formula is infused rapidly and then exhausted in all cases. The pattern is dictated by the system structure that underlies the responses to both the burn and the therapy, rather than specific values of the

parameters in the different cases.

Results of Case 9: Delayed Treatment

Case 9 displays the outcomes from a delay to 8 hours (four additional bars) in the onset of treatment RXTM in a 40% burn. As called for by the Brooke formula, the infusion rate is increased so the prescribed volume RXW is administered within the first 48 hours postburn.

Dehydration deepens at the onset of therapy but the characteristic response again recurs. By 36 hours, the patient descends again into dehydration before maintenance water IVWM establishes a new equilibrium. Thus, doubling the delay in the onset of treatment does not alter the fundamental response pattern.

Results of Case 10: Extreme Case Analysis

The previous cases have all varied from the base or modal case by changing one factor or parameter at a time. Despite wide variations, a consistent pattern of response occurs. Because of the complexities of examining multiple combinations of nonmodal parameter settings, we now examine a case where the parameters are all selected to produce the most extreme possible response.

Consider a small (WTN=35 KG) patient with a large burn (BSAB=.80), a large burn water loss multiplier (BWLM=20), and a delayed onset of treatment (RXTM = 8 hours). At burn time (BRNTM=0), the burn water loss immediately leaps to almost 400 ML per hour, then declines rapidly as the plasma water PW falls to

1/3 its normal value at 4 hours, and to less than 10% of normal at 8 hours.

Urine output UX virtually ceases at 2 hours and -- if the patient were still alive -- the hematocrit HCT would have risen to .87 by the time of treatment. All the parameters mentioned respond rapidly to the Brooke formula infusion RXW2IV.

Unfortunately, the water loss from the burn wound itself increases to almost 500 ML per hour, as plasma water PW is forced above its equilibrium levels, raising the vascular hydrostatic pressure. This extraordinary water loss rate plunges the patient into deepening dehydration again after 24 hours.

The water loss continues, with the administration on the second day of an additional 3500 ML of fluid as called for by the Brooke formula RXW. The dehydration is improved only slightly with the renewal of maintenance water at 48 hours.

Despite the extreme values chosen for all the parameters, and the fact that they are varied simultaneously, the response exaggerates only slightly the fundamental pattern observed in most of the previous cases. This demonstrates clearly that the relationships among the factors, rather than their particular values, determine the properties of the dynamic system response.

DISCUSSION (4.0)

The present, highly preliminary model is a radically different approach to the analysis of fluid therapy in acute burns, which has been stalemated for over a decade. Detailed consideration of the variables in fluid therapy casts enough light on several obscure relationships, however, to believe that some significant new understanding can be derived.

This may eventually include contributing to the formalized methods of modeling biological (and other) systems, as the full power of System Dynamics is brought to bear on medical scientific, diagnostic, and therapeutic problems. The following discussion will suggest some directions that might produce such contributions.

PRESENT MODEL STRUCTURE (4.1)

The plasma water volumes are valid (by definition) at known equilibrium values, and the functions relating them to patients of different sizes operate reasonably well over a broad range of adult sizes. The method of simulating a burn injury, with its control over the time, size, and water loss factors, gives sufficient flexibility to compare it with data from a variety of clinical and experimental situations.

Absolute burn area BSAB and the representation of the burn water loss multiplier BLWM, or unit water loss per square meter, is a well-defined area of uncertainty that was designed for sen-

sitivity analysis. Measurements of this factor have given results varying between four and twenty times normal skin water loss.

The model clearly demonstrates that burn water loss is directly dependent on the unmeasurable state of hydration of the patient, and that the unknown state of hydration confounds all attempts at direct measurement. Furthermore, according to our equations, the standard volumes of fluids called for by the Brooke formula indicate that this factor cannot exceed sixteen (BWL < 16).

More precise evaluation, however, must await the insertion of sodium and an interstitial space. Those relationships should delimit the factor within a much narrower range.

Although -- given its present structure -- the general responses of the model to different test functions are reasonable, that structure itself is not realistic, producing the unphysiologic features of the model's behavior.

The first deficiency of the present model is the realism of the infusion rate, which is difficult to assess. The administration of intravenous fluids was inserted to give the model a realistic driver, even for preliminary examination. The declining rate of administration (with a time constant of 16 hours) represents the typically more rapid initial administration, while fitting the Brooke prescribed quantities during each 8 and 24 hour interval.

In clinical practice, the fluid rate would be modified according to the patient's response as demonstrated by urine output, blood pressure, hematocrit, other signs and laboratory values. The initial rate does seem too rapid, however, and the decline to very low rates is too unresponsive to the actual clinical situation. The model requires a much smoother transition to a new maintenance regimen, perhaps oral, to better emulate clinical circumstances.

Accurate data on plasma volume are not available clinically and the urinary output function is not precise enough for exact feedback control of the IV infusion. Another use of the open loop model, therefore, will be to let the large cumulative feedback experience embodied in the Brooke formulas serve as the guide for a more sensitive and delicate control mechanism than is possible without the aid of the preexisting formulae.

A second major deficiency of the present model is the absence of an interstitial space, that is, the space between the capillaries and the cells that is approximately three times the volume of the plasma itself. In the present model, water remains in the vascular tree and pushes the blood volume, renal output, burn, and other water losses to unrealistic heights.

The lack of an interstitial space, which serves as a reservoir that prevents the body from losing its fluid volume, exaggerates the response to the IV infusion. Our initial approaches to adding an interstitial space reveal a conceptual phenomenon -- not necessarily a problem -- that we have not seen discussed

explicitly in the classical or methodological literature on System Dynamics [39-42].

Intravenous water equilibrates rapidly -- within 5 to 6 minutes -- with interstitial water. Given the hours-to-days timescale of the overall analysis, we could represent the physiologic functions governing the microcirculation (Starling's laws) as instantaneous auxiliary relationships within each integration interval.

The compliance functions for both the cardiovascular system and the interstitial space are highly nonlinear, however, so a new equilibrium could not be determined without fitting and solving a set of complex equations. This is certainly contrary to the spirit of System Dynamics, if it does not violate the law overtly.

Such equations can be easily solved iteratively by assigning them a short first-order time constant and still further shortening DT. It should be noted, however, that the dynamics of the total problem do not require such a short integration interval; it is required only by the mathematical solution of the nonlinear equations.

While this may be convenient, we should be aware that we are inserting levels and integrations where none are required to substitute for analytical solutions. This phenomenon may be more widespread than has previously been realized, and, along with the Euler integration algorithm, may contribute to some of the well-

known problems of "stiff" differential equations. We raise the issue here for consideration and discussion.

Although not a defect of the model itself, clearly specified relations between clinically observable symptoms and signs, including mortality, would generate more specific touchstones between the model, experimental data, and other observable, clinical experience. More importantly, mortality would serve as a value criterion (utility function or figure of merit) for choosing among competing treatment alternatives.

Although the System Dynamics emphasis on stability criteria was and still is critically important in identifying the system and deciding on appropriate management to restore homeostasis, almost all medical treatments induce a trajectory of disequilibrium states before recovery. The price of these transient states may be too high, given any reasonable concept of risk aversion, for the final value gained in terms of longevity and improved life quality, which would be limited to those who survive the treatment.

Thus, we cannot be satisfied to say simply that the curves under different treatment regimens behave more or less similarly, because even a 1 or 2% difference in mortality (on the average) would be considered an important advantage for one of the treatments.

PRESENT MODEL BEHAVIOR (4.2)

The present model seems to operate well with regard to differences in body sizes. In further research the linear proportionalities will be modified to account more precisely for differences by age, sex, obesity, and other body builds.

The expression of many of the functions in ratios derived from the standard person normalizes the model to "dimensionless" quantities specific to the biological system at hand. This eliminates many spuriously specific measurements based on arbitrary units, revealing the more fundamental structural causal relationships among the levels and rates.

Proper dimensionalization might enable a system of measurement that would permit the statement of universal relationships or biological "laws" across different sizes and shapes of particular organisms, if not across species.

The plasma water and blood volume ratios PWR and BVR apply the ratio concept to directly compare the responses of different size patients to different stimuli. The ratios reflect only differences in system structure and parameters, not irrelevant differences in body size.

Even in its present elementary state, the model already exhibits certain interesting complexities in its behavior. After the initial burn, these are largely induced by the overlapping control functions of turning maintenance water on or off, and the quantity and rate of infusion of the IV fluid.

The patterns exhibited in the extreme case are incompatible with life at several points. At present, however, the probability of mortality is not included formally in the model. If it had been, a pattern for mortality would almost certainly have developed in the previous cases, and been exhibited here, although in a more extreme form.

With sufficient treatment, however, all the patients in the present model "survive", i.e., return to equilibrium, regardless of the extremity of their condition at the onset of resuscitation. Thus, without some end point criterion (such as mortality) to serve as a reference, the results from different treatments are difficult to evaluate. Such a function need not be exactly correct to demonstrate the relative outcomes from different treatment regimes.

RELATION OF MODELING TO DATA (4.3)

It is important to examine the validity issue using appropriate concepts and terminology. Whether the model is "valid" or "invalid" is a poorly posed question that inhibits the progressive empirical and conceptual synthesis, and integration of new knowledge that is necessary to bring a model (and understanding) to a point where it gives new insight and begins to suggest useful revisions of therapy and research.

Although the precedent is poor in all biology and social sciences, progressive scientific understanding of a problem in a basic and fundamental sense is nothing more than the progressive

revision of a model. In the early stages of model construction (where we are now), implementing almost any informed suggestion would improve the model and make it more valid and powerful than it is currently.

Developing an appropriate approach to documentation of validity is a critical need for System Dynamics. It has been estimated, for example, that investigations using System Dynamics accelerated the development of an artificial pancreas for insulin and glucose control by at least five years [43]. As we all know, this involved trying dozens, or hundreds of presumably sensible relationships that give unrealistic or even absurd behavior, i.e., they are clearly and convincingly falsified in the routine process of model construction. Yet these experiences rarely appear in the model documentation (including ours).

Thus, the scientific reader asks the reasonable question "How do you know the model is correct?," and cannot see the evidence from the long sequence of tests that gradually constrain the model to conform to the real system. This is especially true for the estimation of coefficients or structural relationships that are still confused in current scientific research with "measurement".

FURTHER RESEARCH AND MODEL DEVELOPMENT (4.4)

Substantial further development is necessary before this preliminary model can be used to study realistic important questions. The most immediate extensions needed are the addition of

sodium, potassium and albumin to the plasma. All these components (water, sodium, potassium and albumin) also need to be modeled in the normal and burn interstitial and cellular spaces.

More realistic versions of the Brooke formula must be implemented and other treatment regimens (colloid, hypertonic saline, etc.) must be formulated. Further testing must be done for the individual functional relationships, e.g., the renal control of water.

Although not yet incorporated in the model, important preliminary work has already been done on modeling capillary membrane exchange and the action of the sodium-potassium "pump" operating between the interstitial and cellular spaces. When these equations are operational, it will be possible to evaluate hypotheses about varying capillary permeability and the probable effects of different treatment formulas more confidently.

Beyond those relationships, the model should be extended to hydrogen ion, one or more burn toxin factors, the effects of other organs such as cardiac function, and the modification of the size ratios for children and the elderly.

The most immediate result of a successful study would be better guidelines for fluid therapy in general, and perhaps special rules for clearly defined circumstances.

Once the model demonstrates a reasonable fit and follow of previous and published data, then filters might be included to estimate parameters for individual patients, as well as explore

the feasibility of incorporating the model directly into a feedback control loop.

The ultimate result could be refined on-line monitoring and control of fluid, electrolyte and colloid infusion. This should be tested extensively in animals before trials in patient treatment.

CONCLUSION (5.0)

A preliminary model of plasma water loss and control has been developed for acute burn patients. Given its structure, the model gives reasonable responses to multiple external inputs, including different body sizes, different sized burns, different loss factors for water from the burn wound, and different levels and times of treatment. With appropriate extensions, the model offers a potentially powerful tool for investigating hypothesized pathophysiological mechanisms for evaluating treatment alternatives and for adapting therapy to individual patients and supplementing their on-line control.

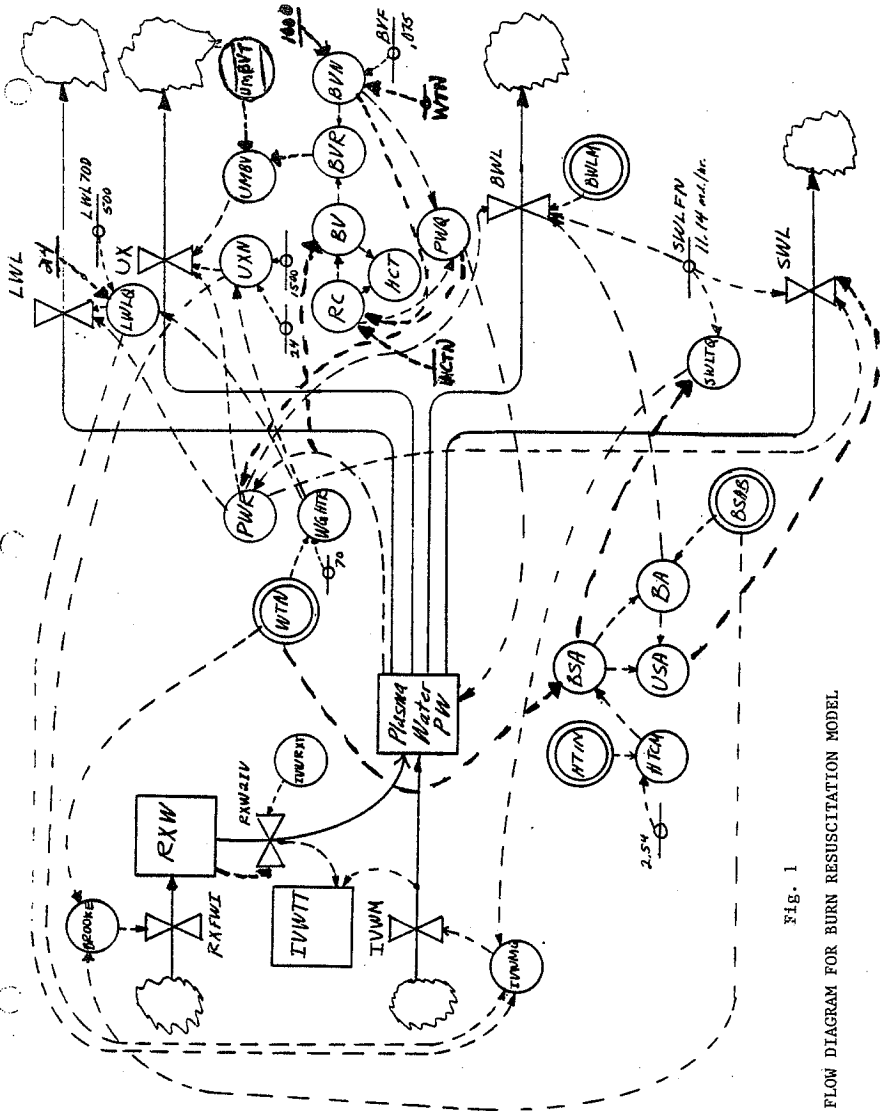

Fig. 1
FLOW DIAGRAM FOR BURN RESUSCITATION MODEL

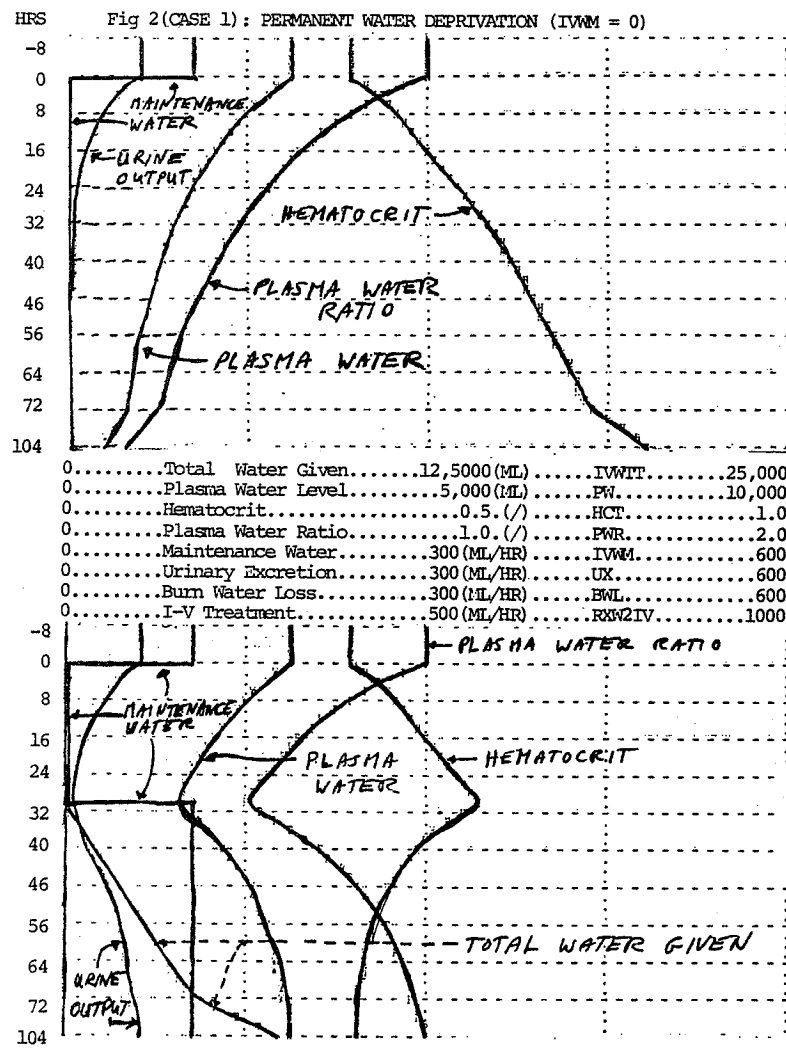
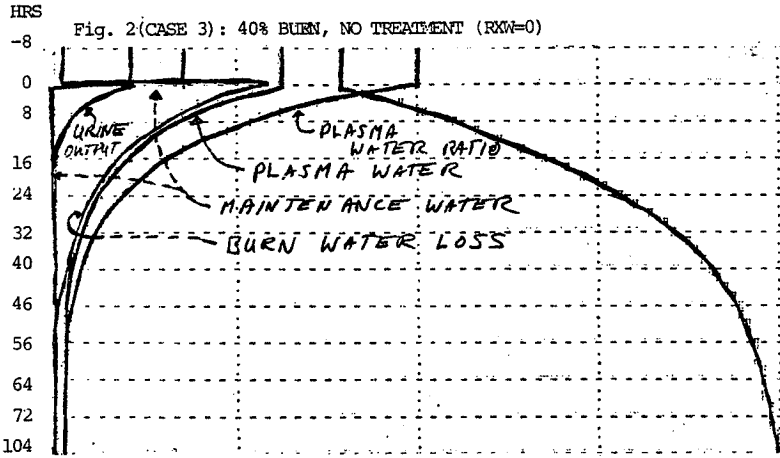

Fig 2 (CASE 2): SHORT TERM (30 HR) WATER DEPRIVATION

0 Total Water Given.....	12,500 (ML) IVWTT.....	25,000
0 Plasma Water Level.....	5,000 (ML) PW.....	10,000
0 Hematocrit.....	0.5 (/) HCT.....	1.0
0 Plasma Water Ratio.....	1.0 (/) PWR.....	2.0
0 Maintenance Water.....	300 (ML/HR) IVWM.....	600
0 Urinary Excretion.....	300 (ML/HR) UX.....	600
0 Burn Water Loss.....	300 (ML/HR) BWL.....	600
0 I-V Treatment.....	500 (ML/HR) RXW2IV.....	1000



0	Total Water Given.....	12,500 (ML)	IVWIT.....	25,000
0	Plasma Water Level.....	5,000 (ML)	PW.....	10,000
0	Hematocrit.....	0.5 (/)	HCT.....	1.0
0	Plasma Water Ratio.....	1.0 (/)	PWR.....	2.0
0	Maintenance Water.....	300 (ML/HR)	IVWM.....	600
0	Urinary Excretion.....	300 (ML/HR)	UX.....	600
0	Burn Water Loss.....	300 (ML/HR)	BWL.....	600
0	I-V Treatment.....	500 (ML/HR)	RXW2IV.....	1000

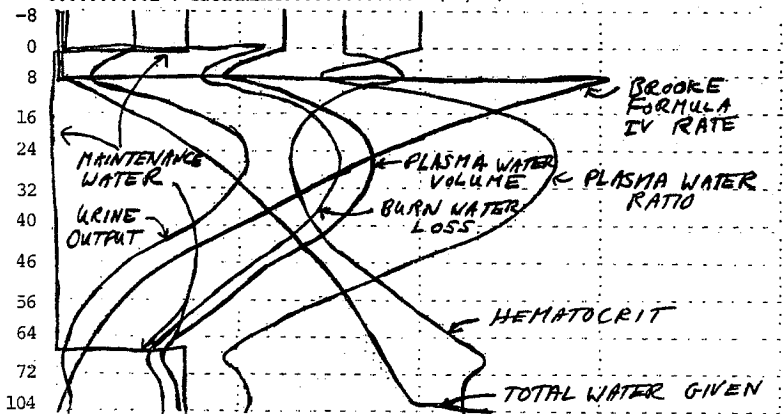
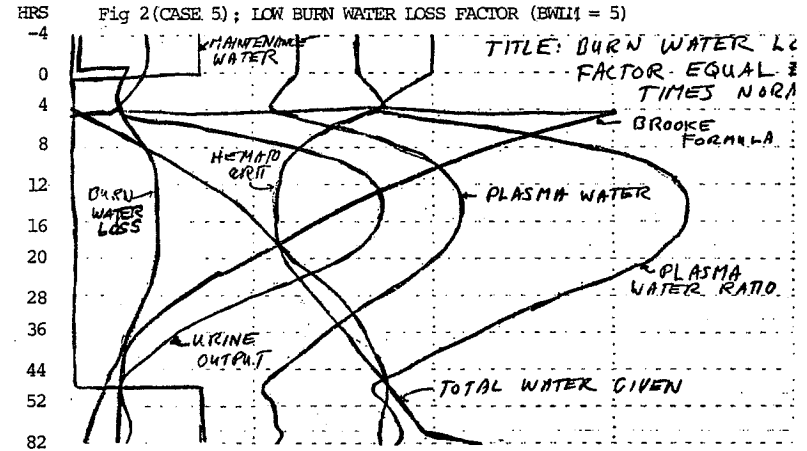

Fig 2(CASE 4): (BASE) 40% BURN WITH TREATMENT (BROOKE)



0	Total Water Given.....	12,500 (ML)	IVWIT.....	25,000
0	Plasma Water Level.....	5,000 (ML)	PW.....	10,000
0	Hematocrit.....	0.5 (/)	HCT.....	1.0
0	Plasma Water Ratio.....	1.0 (/)	PWR.....	2.0
0	Maintenance Water.....	300 (ML/HR)	IVWM.....	600
0	Urinary Excretion.....	300 (ML/HR)	UX.....	600
0	Burn Water Loss.....	300 (ML/HR)	BWL.....	600
0	I-V Treatment.....	500 (ML/HR)	RXW2IV.....	1000

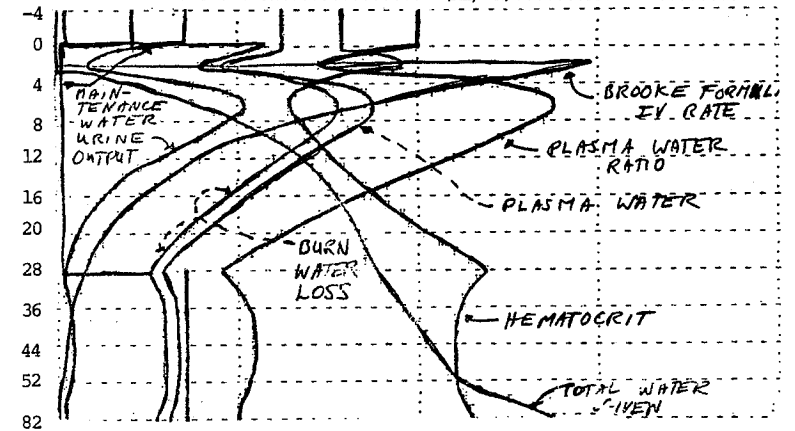
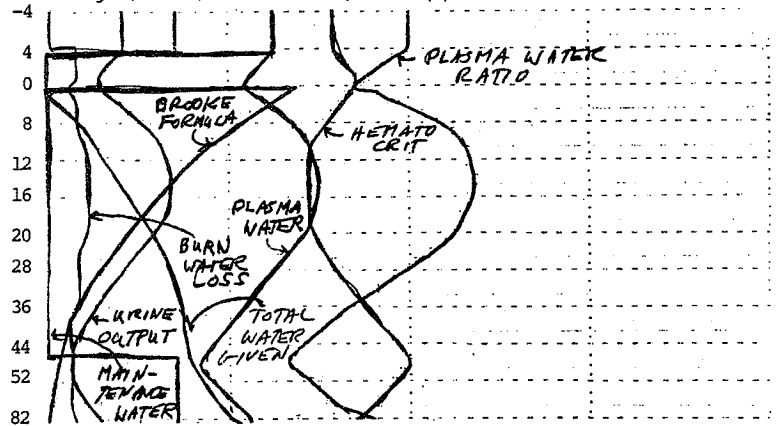

Fig 2(CASE 6): LARGE BURN WATER LOSS FACTOR (BWL1 = 20)

Fig 2 (CASE 7): SMALL BURN (BSAB = .1)



0	Total Water Given	12,500 (ML)	IWWT	25,000
0	Plasma Water Level	5,000 (ML)	PW	10,000
0	Hematocrit	0.5 (/)	HCT	1.0
0	Plasma Water Ratio	1.0 (/)	PWR	2.0
0	Maintenance Water	300 (ML/HR)	IWMM	600
0	Urinary Excretion	300 (ML/HR)	UX	600
0	Burn Water Loss	300 (ML/HR)	BWL	600
0	I-V Treatment	500 (ML/HR)	RWIV	1000

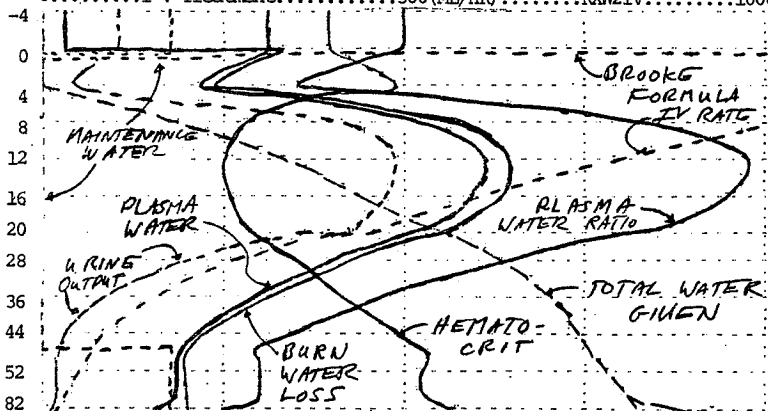
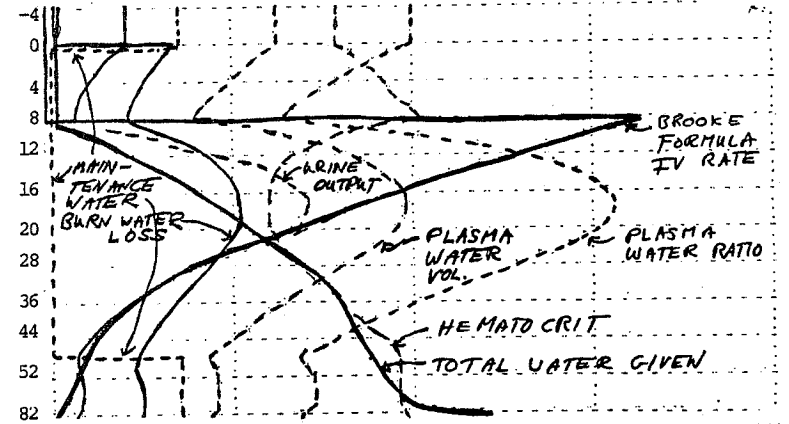

Fig 2 (CASE 8): LARGE BURN 80% BODY SURFACE AREA (BSAB = .8)

Fig 2 (CASE 9): DELAYED TREATMENT (RXIM = 8HRS)



0	Total Water Given	12,500 (ML)	IWWT	25,000
0	Plasma Water Level	5,000 (ML)	PW	10,000
0	Hematocrit	0.5 (/)	HCT	1.0
0	Plasma Water Ratio	1.0 (/)	PWR	2.0
0	Maintenance Water	300 (ML/HR)	IWMM	600
0	Urinary Excretion	300 (ML/HR)	UX	600
0	Burn Water Loss	300 (ML/HR)	BWL	600
0	I-V Treatment	500 (ML/HR)	RWIV	1000

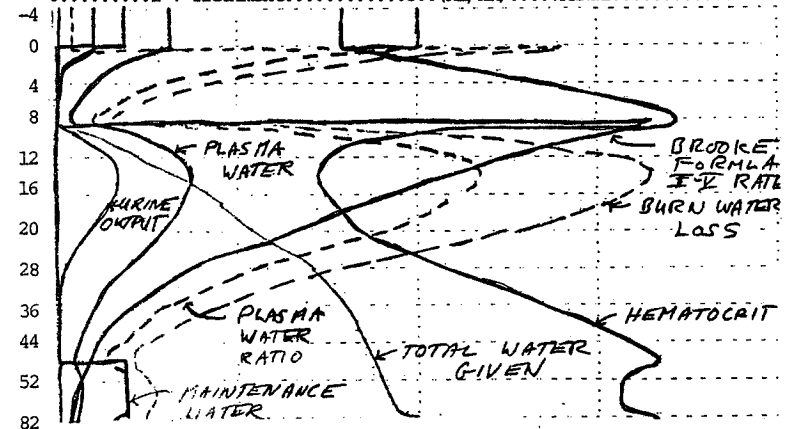

Fig 2 (CASE 10): EXTREME CASE

* B35: BURN FLUID RESUSCITATION MODEL 3, VERSION 5

* - - - - - PATIENT PARAMETERS - - - - -

C WTN=70 KG WEIGHT NORMAL/NTL FOR PATIENT

A WGHTR=WTN/WTN70 WEIGHT RATIO [/]

A WGHT.K=WTN-(PWQ-PW.K)/1000 WEIGHT [KG]

C HTIN=70 HEIGHT [IN] APPENDIX 1

A HTCM=2.54*HTIN HEIGHT [CM]

A BSA=.007184*EXP(.425*LOGN

X (WTN))*EXP(.725*LOGN(HTCM)) BODY SURFACE AREA [M2]

C BSAB=0.4 BODY SURFACE AREA BURNED [/]

A BA=BSAB*BSA BURN AREA [M2]

* > > > PLASMA WATER EQUATIONS < < < < <

L PW.K=PW.J+DT*(IVWM.JK+RXW2IV.JK-LWL.JK-

X UX.JK-BWL.JK-SWL.JK) PLASMA WATER (ML)

N PW=PWQ PLASMA WATER NTL/NRML [ML]

A PWQ=BVN-RC PLASMA WATER EQUILIBRIUM (ML)

* - - - - - URINE OUTPUT EQUATIONS - - - - -

R UX.KL=UXN*UMB.V.K*PWR.K URINARY EXCRETION [ML/HR]

A UXN=WGHTR*UXN724/24 URINE EXCRETION NRML [ML/HR]

C UXN724=1500 URIN XCRTN NRML 70KG PT [ML/DY]

C WTN70=70 WGHT NRML 70KG PT [KG]

A UMB.V.K=TABHL(UMBVT,BVR.K,0.4,1.4,.2)

* URIN XCRTN MPR FM BLD VOL (ML/HR)

T UMBVT=0.0/0.1/0.43/1.0/1.7/2.4

* URN XCRTN MPR FM BLD VOL TABL

* < < < BLOOD VOLUME EQUATIONS < < <

A BVR.K=B.V.K/BVN BLOOD VOLUME RATIO [/]

A HCT.K=RC/BV.K HEMATOCRIT [/]

A EV.K=RC+PW.K BLOOD VOLUME (ML)

A RC=HCTN*BVN RED CELL VOLUME [ML]

C HCTN=.40 HEMOCRIT (NORMAL) (/)

A BVN=BVF*WTN*1000 BLOOD VOLUME NORMAL [ML]

C BVF=.075 BLD VOL FRCTN (OF WGHT NRML) [/]

* < < < SKIN WATER LOSS EQUATIONS < < <

APPENDIX 1

pg. 2

R BWL.KL=BA*SWLFN*BWLM.K*PWR.K BURN WATER LOSS (ML/HR)

C SWLFN=11.14 ML/HR/M2 SKIN WATER LOSS FACTOR NRML

A SWLTQ=BSA*SWLFN SKN WTR LSS TTL EQLBRM (ML/HR)

A BWLM.K=1.0+BURN.K BURN WATER LOSS MULTIPLIER (/)

A BURN.K=STEP(BWLI,BRNTM) BURN WATER LOSS INCREMENT (/)

C BRNTM=0 BURN TIME (TIME)

C BWLI=9 BRN WTR LSS (MPR) INCRMNT (/)

A PWR.K=PW.K/PWQ PLASMA WATER RATIO [/]

R SWL.KL=SWLFN*USA*PWR.K (UNBURNED) SKN WTR LSS [ML/HR]

A USA=BSA-BA UNBURNED SKIN AREA

R INS.KL=SWL.JK+LWL.JK INSENSIBLE WATER LOSS

* < < < LUNG/GI WATER LOSS EQUATIONS < < <

R LWL.KL=LWLQ*PWR.K LUNG/GI WATER LOSS [ML/HR]

A LWLQ=WGHTR*LWL70D/24 LUNG/GI WTR LSS EQLBRM [ML/HR]

C LWL70D=500 LUNG/GI WTR LSS 70KG PT (ML/DY)

* # # # # # # # # TREATMENT EQUATIONS # # # # # # # #

R IVWM.KL=IVWMQ*(1-STEP(MWCO,MWCOTM))+

X MWCO*STEP(1,MWTOTM)) MAINTENANCE WATER [ML/HR]

C MWCO=1 MANTNC WTR CUTOFF(0=NOT CUT OFF;

* 1=MW OFF AT MWCOTM,ON AT MWTOTM)

C MWCOTM=0 MW CUTOFF TIME (TIME)

C MWTOTM=48 MW TURNON TIME [TIME]

A IVWMQ=LWLQ+SWLTQ+UXN MNTC WATER EQBM (ML/HR)

L RXW.K=RXW.J+DT*(RXFWI.JK-RXW2IV.JK)

* RX WATER (IV) REMAINING [ML]

N RXW=0 RX WATER NTL (BEFORE BURN) (ML)

R RXFWI.KL=PULSE(FORMW/DT,RXTM,INTVL)

X 48HR RX FORMULA WTR INPUT (ML)

A FORMW=RXWCO*BROCKE 48HR FORMULA FOR WATER (ML)

A BROCKE=1.5*(2*WTN*BSAB*100+

X 2000) BROCKE WTR 48HR FORMULA (ML)

C RXWCO=1
 C RXTM=4.0 HRS
 C INTVL=1000
 R RXW2IV.KL=RXW.K/IVWRXT
 A IVWRXT=(48-RXTM)/3
 L IVWTT.K=IVWTT.J+DT*(IVWM.JK*STEP(1,0)+RXW2IV.JK)
 *
 N IVWTT=IVWTT0
 C IVWTT0=0
 \$

⁴¹
 RX IV WATER CUTOFF (0=OFF, 1=ON)
 TREATMENT ONSET TIME APPENDIX 1
 LONG INTVL TO DEFER 2ND PULSES pg 3.
 TREATMENT WATER TO IV (ML/HR)
 PRESCRIBED WATER CONTROL TIME
 IV WATER TOTAL GIVEN [ML]
 IV WATER TOTAL INITIAL [ML]

578

42

BIBLIOGRAPHY

- [1] Foster, R.O., Soeldner, J.S., Tan, M.H., and Guyton, J.R., Short-term Glucose Homeostasis in Man, J Dynamic System Measurement & Control 1: 308-314 (1973).
- [2] Silverman, William S., Dynamics of the Human Menstrual Cycle, Senior Thesis, Great Barrington, Mass (1979).
- [3] Wegman C., Simulation of Freud's Counter-Will Theory, Behavioral Science 22 (3): 218-233 (1977).
- [4] Estrup, C., The Dynamics of Body Metabolism, Systems Dynamics Group, Technical Memorandum D-1936, MIT (1973).
- [5] Richmond, Barry, Toward a Structural Theory of Cancer, System Dynamics Group, Technical Memorandum D-2718, MIT (1977).
- [6] Grodins, F.S., Control Theory in Biological Systems, Columbia, NY (1963).
- [7] Deland, E.C., and Bradham, G.B., Fluid Balance And Electrolyte Distribution in The Human Body, Memorandum RM-4347-PR, The Rand Corporation (Feb. 1965).
- [8] Mesarovic, M.D., Systems Theory and Biology, Springer, New York (1968).
- [9] Riggs, D.S., Control Theory and Physiological Feedback Mechanisms, Williams and Wilkins, Baltimore (1970).

- [10] Iberall, A.S., Toward a General Science of Viable Systems, McGraw Hill, New York (1972).
- [11] Guyton, A.C., Circulatory Physiology: Cardiac Output and its Regulation, Saunders, Philadelphia (1973).
- [12] Guyton, A.C., Integrative Hemodynamics, ch. 6 in Sodeman's Pathologic Physiology: Mechanisms of Disease, pp. 149-176, Sodeman, W.A. (ed.), Saunders, Philadelphia (1974).
- [13] Talbot, S.A., and Gessner, U., Systems Physiology, Wiley, New York (1973).
- [14] Cooney, D.O., Biomedical Engineering Principles, Marcel Dekker, New York (1976).
- [15] Rideout, V.C., Simulation in Life Sciences, ch 12 in Simulation of Systems, pp. 39-46, Dekker, L. (ed), North-Holland, Amsterdam (1976).
- [16] Gold, H.J., Mathematical Modeling of Biological Systems, Wiley, New York (1977).
- [17] Marmarelis, P.Z., Marmarelis, V.Z., Analysis of Physiological Systems, Plenum Press, New York (1978).
- [18] Finkelstein, L., and Carson, E.R., Mathematical Modeling of Dynamic Biological Systems, Research Studies Press, Forest Grove (1979).

- [19] Carson, E.R., Cobelli, C., and Finkelstein, L., Modeling and Identification of Metabolic Systems, Am J Physiol 240: 120-129 (1981).
- [20] Spain, J.C., Basic Models in Biology, Addison-Wesley, Reading Mass. (1981).
- [21] Moncrief, J.A., Effect of Various Fluid Regimens and Pharmacologic Agents on the Circulatory Hemodynamics of the Immediate Postburn Period, Ann Surg 164: 723-752 (1966).
- [22] Moyer, C.A., and Butcher, H.R., Jr., Burns, Shock and Plasma Volume Regulation, C.V. Mosby, St Louis (1967).
- [23] Monafu, W.W., The Treatment of Burn Shock by the Intravenous and Oral Administration of Hypertonic Lactated Saline Solution, J Trauma 10: 575-586 (1970).
- [24] Baxter, C.R., Problems and Complications of Burn Shock Resuscitation, Surgical Clinics North America 58 (6): 1313-1322 (1978).
- [25] Moylan, J.A., Jr., Reckler, J.M., and Mason, A.D., Resuscitation with Lactate Saline in Thermal Injury, Am J Surg 125: 580-584 (1973).
- [26] Baxter, C.R., Fluid Volume and Electrolyte Changes of the Early Postburn Period, Clinics in Plastic Surgery 1: 693-709 (1974).

- [27] Artz, C.P., Burns Updated, J Trauma 16: 3-15 (1976).
- [28] Wachtel, T.L., McCahan, G.R., Jr., Monafo, W. W., Jr., Fluid Resuscitation in a Porcine Burn Shock Model, J Surgical Research 23: 405-414 (1977).
- [29] Pruitt, B.A., Advances in Fluid Therapy and the Early Care of the Burn Patient, World J Surg 2: 139-150 (1978).
- [30] Pruitt, B.A., Jr., Fluid and Electrolyte Replacement in the Burned Patient, Surgical Clinics North America 58: 1291-1312 (1978).
- [31] Baxter, C., Fluid Resuscitation, Burn Percentage, and Physiologic Age, J Trauma Supplement 19: 864-865 (1979).
- [32] Consensus Development Conference: Supportive Therapy in Burn Care, J Trauma 19 (11): 812-818 (1979).
- [33] Morton, J.H., Fluid Replacement in Patients With Large-Area, Full and Partial-Thickness Burns, Arch Surg 114: 247-252 (1979).
- [34] Mason, A.D., The Mathematics of Resuscitation, J Trauma 20: 1015-1020 (1980).
- [35] Bowman, R.J., and Westenskow, D.R., A Microcomputer-Based Fluid Infusion System for the Resuscitation of Burn Patients, IEEE Transactions on Biomedical Engineering BME-

- 28: 475-479 (1981).
- [36] Virgilio, R.W., Rice, C.L., Smith, D.E., James, D.R., and Zarins, C.K., Crystalloid vs Colloid Resuscitation: Is One Better? A Randomized Clinical Study, Surgery 85: 129-139 (1979).
- [37] Cohen, S., An Investigation and Fractional Assessment of the Evaporative Water Loss Through Normal Skin and Burn Eschars Using a Microhygrometer, Plastic and Reconstructive Surg 7: 475-486 (1966).
- [38] Larkin, J.M., and Moylan J.A., Evaporative Water Losses in Patients Treated in a Laminar Flow Burn Unit, J Surg Res 24: 65-69 (1978).
- [39] Forrester, J.W., Industrial Dynamics, MIT Press, Cambridge (1960).
- [40] Forrester, J.W., Principles of Systems, 2nd ed., Wright-Allen Press, Cambridge (1968).
- [41] Randers, J., Elements of the System Dynamics Method, MIT Press, Cambridge (1980).
- [42] Roberts, E.B., Managerial Applications of System Dynamics, MIT Press, Cambridge (1977).
- [43] Soeldner, S., Personal Communications, May 1983.