

Enlarging the Paradigm: Historical View From 1973 until 1983

Hermann Krallmann

Technische Universität Berlin

Summary

This paper will provide an overview of the past ten years describing the activities of enlarging the paradigm of System Dynamics (SD). The first chapter tries to explain why this has been done. Chapter two is concerned with the optimization of SD models. The global optimization of System Dynamics models is realized by its integration into a higher level feedback loop structure. The use of optimal variables in SD models is handled by linear programming models.

In chapter three the integration of SD and Input-Output models has been realized to describe complex macroeconomic systems. Chapter four describes System Dynamics models as decision support systems based on model and methods base systems. The last chapter is concerned with a new developed approach - an integration of the methods ABRAHAM/ISAC and Petri nets-which is able to build models of System Dynamics type on a proved theoretical basis.

I. Why enlarging the paradigm

This question has simply to be seen with respect to the fundamental objective to find the best possible solution in the process of modelling complex parts of the real world. Fig. 1 shows the underlying structure of the process of finding the adequate methods concerning the characteristics of the problem, the objective system and the available methods.

Characteristics of problems are

- number of variables (heterogenous components; hard and soft variables)
- relationship of variables (feedback nature; nonlinear)
- problem dynamics, bad structured systems etc.

The objective system of a project is defined e.g. to describe or to explain real phenomena, to forecast their behaviour and/or to provide optimal decision. With respect to the characteristics of the methods a single or a number of methods integrated will be used which is or are most congruent to the characteristics of the specific problem and the objective system.

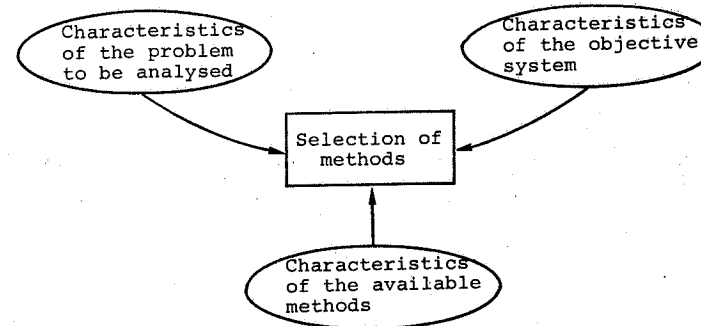

Fig. 1: Selection of Methods

Evidently the above explanations don't offer a scientific justification for enlarging the paradigm but a very pragmatic one. The following projects realized in business or administration try to prove the last statement.

II. Optimization of System Dynamics models

1. Global Optimization

The global optimization of System Dynamics models is realized by the feedback structure described in Fig. 2:

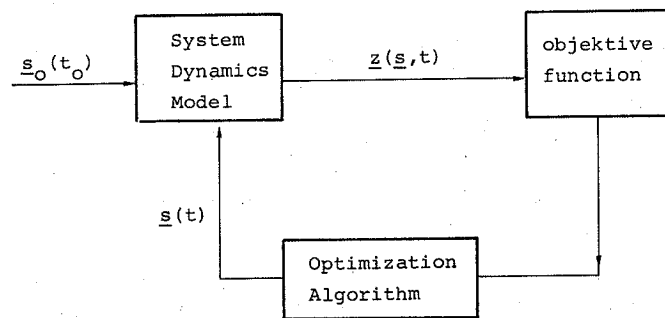

Fig. 2: System Dynamics model in a feedback loop structure

The control system is identical with the corresponding System Dynamics model, whereby its output variables (state vector $\underline{z}(s, t)$) are compared with the objective function of getting the deviations of the desired and actual values. The controller - the optimization algorithm - tries by modifying the control vector $\underline{s}(t)$ (the input variable of the system dynamics model) to minimize these deviations in order to fit the objective function (see Fig. 2).

The objective can be defined as to determine an optimal control vector $\underline{s}(t)$, such that the state vector, $\underline{z}(\underline{s}, t)$ follows a feasible and user defined path as closely as possible, which is described in the objective function. The problem is to minimize the deviation of each state trajectory, $\underline{z}(\underline{s}, t)$, $k=1, 2, \dots, m$ from user defined state trajectory, $r_k(t)$, $k=1, 2, \dots, m$

$$\text{Min } U(\underline{s}, t) = \sum_{k=1}^m \left| \frac{z_k(\underline{s}, t) - r_k(t)}{z_k(\underline{s}, t) - r_k^u(t) + w_k^1(t) / z_k(\underline{s}, t) - r_k^l(t)} \right|$$

To allow for a variation in acceptable values we introduce upper and lower boundary $r_k^u(t)$, $r_k^l(t)$ of the target interval for state variable z_k at sampling time t and add weighting

factors $w_k^u(t)$, $w_k^l(t)$ for the deviation from the upper and lower boundary.

To normalize all state variables values and to emphasize or deemphasize state variables the objective function $U(\underline{s}, t)$ can be defined as follows

$$\text{Min } U(\underline{s}, t) = \sum_{k=1}^m \left| \frac{w_k^u(t) / z_k(\underline{s}, t) - r_k^u(t) + w_k^l(t) / z_k(\underline{s}, t) - r_k^l(t)}{z_k(\underline{s}, t) - r_k^u(t) + w_k^1(t) / z_k(\underline{s}, t) - r_k^1(t)} \right|$$

The Fig. 3 shows simplified behaviour of the global optimization procedure.

The optimization algorithm acting as controller is in most of the cases the so-called razor search-method developed by Bandler und Macdonald. The algorithm a modified pattern search method, belonging to the direct search and climbing procedures for optimizing multidimensional problems.

The pattern search-method has here the main task in this problem of directing the output variables $z_k(\underline{s}, t)$ of the model into the user defined solution space described in the objective function $U(\underline{s}, t)$. To do so, the modeller must vary the parameters of the control vector $\underline{s}(t)$ by exploratory moves.

Experience with pattern search-method indicates that the procedure is very efficient in reaching an optimum also in circumstances where the feasible region for the control vector has fairly narrow valleys in it. Classical methods (such as steepest descent-, generalized Newton-Raphson-, Fletcher-Powell method etc.) slow down or even fail to get an optimum in such cases.

An important modification of the pattern search procedure is the so-called razor search method. This routine overcomes the difficulties of discontinuous partial derivatives with respect to the control variables. Otherwise efficient search

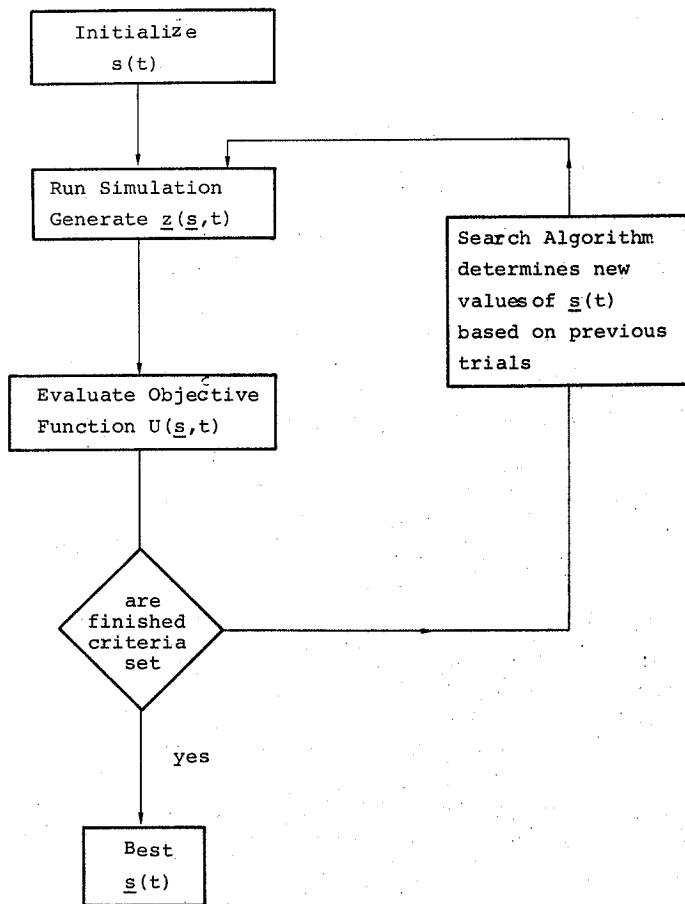

Fig.3 Simplified flow diagram of global optimization

methods fail to converge, particularly when the objective function's hyperspace includes narrow curved valleys in the vicinity of the path of discontinuous partial derivatives.

The razor search routine normally overcomes these difficulties by a search strategy that begins with a version of pattern search and then applies this until it fails.

Then, the procedure automatically selects a random point in the immediate neighbourhood. The random point is selected so that:

$$s_i(t) = s_i^0(t) + pR(n) \cdot \epsilon$$

where $s_i(t)$ is the new value of the i th control variable, $s_i^0(t)$ is the old value of the i th control variable, p is a scale factor, $R(n)$ produces random numbers between -1 , and $+1$, and ϵ represents the current value of the exploratory increment.

When the pattern search fails again the same valley (or boundary) is assumed to be responsible, and an attempt is made to establish a new pattern in the direction of the minimum. The process is automatically repeated until any of several possible terminating criteria are satisfied.

The razor search presented in this paper has two further essential characteristics

- 1) The exploratory increments depend on the total progress made between the previous two base points. Therefore, they automatically increase or decrease in accordance with previous successes or failures, respectively.
- 2) When a pattern move plus exploratory moves fail, the pattern is not immediately discarded. Instead, the same procedure is repeated closer to the base point. If this effort also proves unsuccessful, the procedure is attempted in the opposite direction.

The razor search-method has been successfully applied to microwave optimization.

1.1 Global Optimization applied to Business applications

1.1.1 Optimal Control of a Chemical Process

- "Polycondensation" plant (Krallmann, 1976)

At the production of the synthetic fibre the polycondensation is a very important process. Polycondensation means the amalgamation of simple molecules of same or different kind to new and larger chain of molecules. During this process by-products as e.g. water and alcohol are separated. The output of the polycondensation plant will be spun to thread with high speed. As the essential assumption and condition for the spinning process exists, that the output viscosity has to be constant or is limited by an upper and lower boundary. The threads will get brittle below the lower boundary and are difficult to spin outside the upper boundary. Time variant behaviour of the input material and the unsteady input viscosity are the disturbances of this condition. By varying the control variables temperature and pressure these disturbing variables can be eliminated. The following chapters describe a heuristic procedure combined with a computer-based model to control the output viscosity in defined boundaries.

The System Dynamics model applied to this optimization problem describes the chemical process inside the main condenser of a "TPA"-plant. The adjustments to the pressure and temperature should be computed at each point of time t_i for a throughput changes from 900 kilogram per hour (kg/h) down to 600 kilogram per hour (kg/h). The primary condition is that the viscosity SVE at the entry of the main condenser remains constant (SVE = 390 SV-units) while viscosity of the output SVA1 should remain between defined limits.

The equations written in DYNAMO language, describe the structure of the problem. The System Dynamics model has to be extended by the three external FORTRAN subroutines LAST, BER and BER1, which are linked to the model during the running time.

The system dynamics model of the polycondensation plant has been integrated as a control system into the feedback loop. The control vector $\underline{s}(t)$ - i.e. the input variable to the model - consists of the two components temperature T and pressure V. The viscosity SVA1 is the state vector $\underline{z}(\underline{s}, t)$ controlled by the optimization algorithm.

The optimization algorithm, the razor search-procedure, is responsible for varying the parameters of the control vector A (pressure) and B (temperature) so that the state variable SVA1 follows a user defined objective function.

The control variables, pressure and temperature, may only be modified within fixed boundaries. The current limits for the pressure are $1.0 \leq V \leq 4.0$ (Torr). The lower boundary of the temperature is given at 290°C and the upper is 300°C . The tolerance zone for the viscosity SVA1 is $\text{LIM1} \leq \text{SVA1} \leq \text{LIM2}$. At each point of time t_i , the optimization algorithm razor search tries to vary the parameters A and B of the control variables, pressure and temperature, within the defined boundaries so that the state variable SVA1 follows the desired value SVA1 as closely as possible within the desired limits.

The optimization algorithm razor search succeeds in controlling the viscosity SVA1 with the help of continuous and simultaneous modifications of the control variables, pressure and temperature, so that SVA1 will always stay within the defined boundaries. Figure 4 shows the changes in pressure and temperature needed to stabilize viscosity SVA1 within the defined range.

In fact all chemical processes have inherent time lags. Considering these time lags any parameter changes imposed on the control vector $\underline{s}(t)$ will result in delayed actions of the state variables $\underline{z}_i(\underline{s}, t)$. Because of these inherent characteristics, the razor search procedure has to be modified by an additional logical step and different program changes. To take care of the impact of the parameter changes

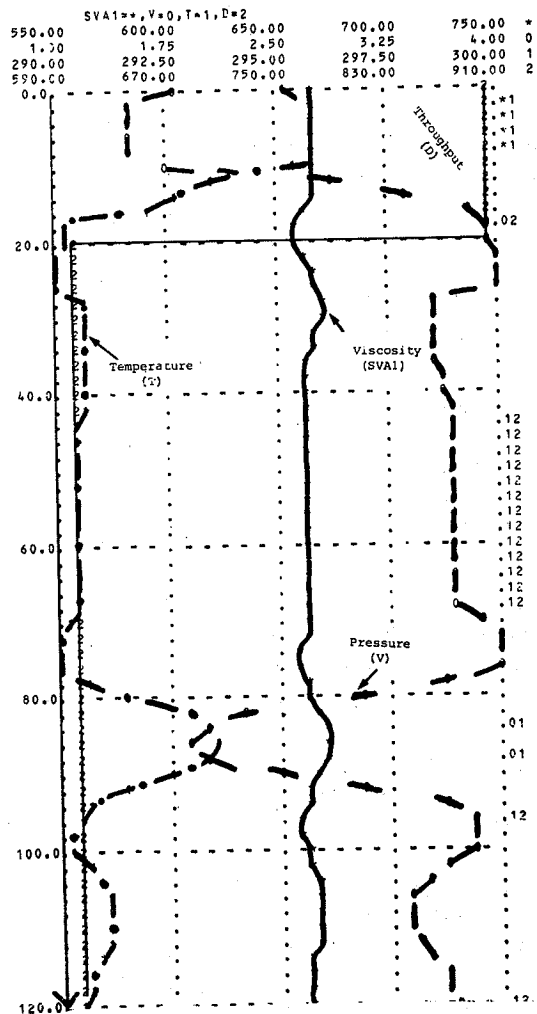

Fig.4 Plotted results of the Polycondensation plant model
($0 \leq t \leq 100$)

on $\underline{s}(t)$, the system dynamics model has to be simulated ahead by a definite time interval which corresponds to the longest delay constant of the model. If the parameters of $\underline{s}(t)$ result in an improvement of $z_i(\underline{s}, t)$ at the final point of time of the "advance simulation" the procedure is reemployed at time print t_i+1 to find a new set of parameter combinations for $\underline{s}(t)$, and the "advance simulation" is repeated.

1.1.2 Optimal Control of Investment Strategies in the Tanker Market (Krallmann a. Nestaas 1979a)

Another example of optimizing a complex system should only be presented in a summarized way. The essential difference between the above described study consists in the use of the evolution strategy method as optimization routine instead of the explained razor search procedure.

The main objective of this study consists in making a contribution to overcome the crisis on the tanker-market. The crisis is caused by a surplus of tanker-tonnage and a tanker-fleet too big.

The conditions of this market are described by three essential factors:

- 1) The group of demanders at tanker-tonnage consists mainly in seven large oil companies¹⁾ while the group of suppliers consists in about five hundred shipowners.
- 2) The demand at tanker-tonnage is relative inflexible because of being determined by the total economic demand at oil. The small number of parameters of action the oil companies have to influence their demand at tanker-tonnage can be described as stock changes and as a limited possibility, the structure changes of purchase, which causes changes in the route of transportation.

1) Exxon, Royal Dutch/Shell, British Petroleum Co., Texaco Inc., Mobil Oil Corp., Standard Oil Co. of California

Caused by increasing specialization the suppliers (the shipowners) have become more and more dependent of the tanker-market. Their parameters of action are reduced to changes in tanker-capacities, changes in speed and in time of loading and unloading.

3) The industry of ship-building is the third main factor. The shipyards have adapted to the demand of the ship-owners e.g. in the way that those are able to build large ships in a short time. With corresponding docks these shipyards are directly dependent of the tankermarket.

This set of problems described in a rough way is presented in detailed model based on System Dynamics and problem oriented FORTRAN algorithms.

The main parts of model are the demand sector, the supply sector, the capital sector, the sector of the tanker-market, and the sector of ship construction. The demand sector describes the world demand and supply situation of crude oil and the behaviour of the demanders at the market. The sector of the tanker-market analyses the technical specifications and the development as well of the tanker-fleet as of the combined ships. The important factors concerning the route of transportation, the pipelines and canals (e.g. Suez Canal) are integrated. The capital sector deals with profits, costs and the strategies of investments of tanker-shipowners. The data used in the model are based on statistics and explorations (forecasts) of INTERTANKO (1976), OECD (1973), EXXON (1977) , UNITED NATIONS "Yearbook of International Trade Statistics" (1975) , Shipping Statistics and Economics (1977) , Institute for Shipping Research, Bergen etc.

The objective of this study consists in supporting decisions to overcome the crisis at tanker-market with approximate optimal investment strategies under the assumption of a reasonable freight rate. The principle of a feedback loop can be used to solve the optimization of such a complicated model of the tanker-market. In this procedure the System Dynamics model corresponds to the control system, the optimization procedure "Evolution strategy" is identical to controller. In the objective function the deviations of the desired and actual values are computed. The objective is to control the state vector $\underline{z}(\underline{s}, t)$ "freight rate" (output variable of the System Dynamics model) in defined boundaries by varying the parameters of the control vector $\underline{s}(t)$ (input variables of the system dynamics model) which are limited between upper and lower boundaries. In this case the control vector is identical with the different investment strategies of the tanker-shipowners. In the model the tanker fleet is classified into nine categories as a function of size e.g. the control vector has nine parameters. Modifying the element $s_i(t)$ of the control vector means that the investment is performed in the i th category and with the corresponding volume.

The evolution strategy, with multiple elements, is an iterative direct search method for optimization problems with nondiscrete parameters. It determines minimum of a nonlinear function of an arbitrary but definite number of variables. Derivatives of the object-function would not be used. Conditions in form of inequalities could be taken into consideration. The user has to specify initial values for the variables and the increment.

Under the control of the optimization algorithm the model produces results with the following main characteristics (see Fig. 5):

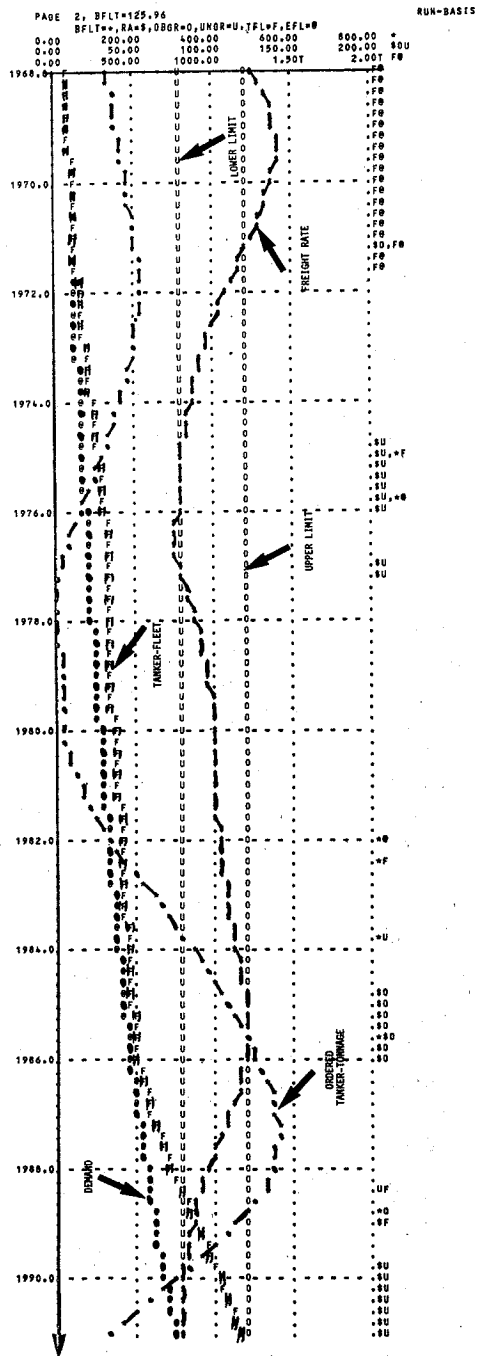

Fig.5: Demand, Supply, freight rate and ordered tanker-tonnage

- 1) in periods with high freight rates the parameters of the control vector are chosen so that tankers below 300000 tdw. (ton dead weight) are ordered with priority;
- 2) an opposite situation occurs in periods with low freight rates.

The following facts have to be done to improve the model to get a powerful tool of supporting investment decisions of tanker-shipowners:

- investigation and improvement of the data base,
- investigation and improvement of the model structure.

1.1.3 Optimal introduction of innovative products into a competitive market (Krallmann 1980a)

After several years of work of research and development a known German enterprise has introduced into the market a product for the disgerminating of water on the technologically new basis of the anodic oxidation. The competitive advantage based on the innovative character as well as the high technical reliability of the product and coincidentally missing negative accompanying symptoms as other classical procedures (taste changing by chloric tablets etc.) have given a justified argument for good market expectations. However, within the first year the expected market success could not be realized. As a consequence, the enterprise initiated an investigation of the problem for analysing the small turn-over. For this purpose a project team of the responsible managers and external consultants was established.

It was intended to fulfill the following tasks successively by the project study:

- Analysis of the essential variables as well as of the relevant structure of the existing problem (e.g. analysing the bottlenecks in the marketing process of the relevant product).
- Definition and analysis of different marketing strategies for increasing the turn-over.
- Documentation of the consequences of different market strategies on the profitability of the product.

In first discussions with brainstorming character first of all an analysis of the problem was performed. On this occasion a qualitative model was constructed based on description techniques which documented particularly the following matters of facts:

- detailed structure of the main objective variables (customers' potential)
- influence factors on the main objective variables and their characteristics
- detailed structure of the sales flows etc.

Important conclusions of this first phase of the project study consisted in:

- the importance of system variables which had so far been neglected (i.e. trade cycle, three divided trade structure), and
- the great importance of observed facts as e.g. delivery delays.

The System Dynamics approach had been applied to formulate a formalized quantitative model based on the qualitative one. In the process of the model development the different modeling strategies were quantitatively confirmed by a market research institute. The single phases of the model building process occurred in an interactive feedback process between the external consultants and the responsible people of the company in order to enhance on the one hand the

quality of the model and to strengthen on the other hand the acceptance and the confidence of the model users (see Keen 1980, p. 36). The model system to be developed was classified into five functional submodels with the intention to reuse it for sequence products with the same distribution structure (producer - trade - final user). The standardization of these modular subsystems (e.g. subsystem 4 - execution of trade orders) was done from the point of view of larger modifications and modular extension. The result is represented in fig. 6 as a basic structure of the model.

The decision to represent the introduction process of an innovative product line in a computer supported manner was the basis for the development of a future model base system (see in detail chapter IV.).

In the subsystem 1 "investigation of real purchase intentions" all the behaviour attitudes and relations are summarized which are determinant for the monthly number of resolute buyers. Exogenous variables to this subsystem are represented

- the recommended standard price for the product
- expenses of the enterprise for quality improvements as well as
- the promotion activities adjusted to the client and to the consignees of the mailing action (physicians and pharmacists).

An endogenous variable to this subsystem within the system boundary is the

- average delivery time -

generated in the subsystem 4, which influences in a negative manner the number of firmly determined buyers with increasing tendency.

In the subsystem 2 "supplier structure" the trade's opinion with regard to the product is modeled. As an endogenous variable the customers' demand of the subsystem 1 (jump promotion) has a positive influence on the dealer (trade);

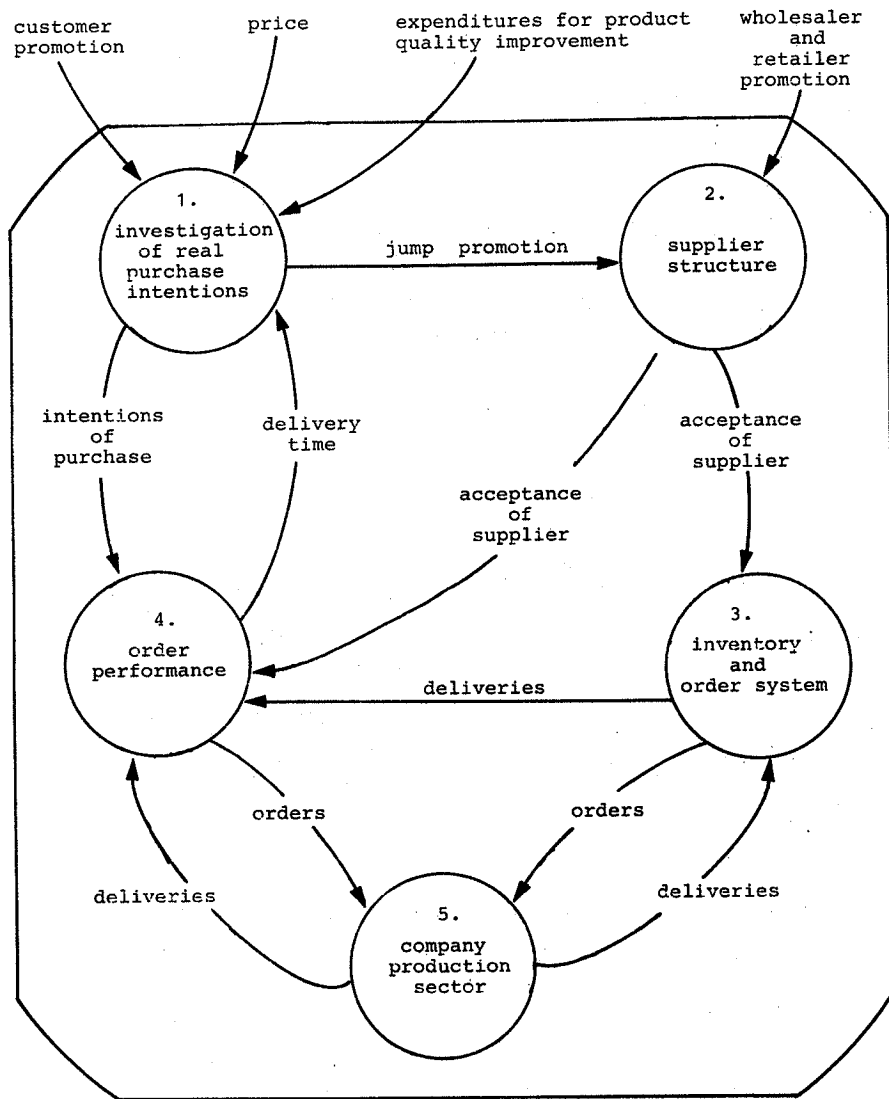

Fig. 6: Structure of the model

as an exogenous variable the promotion activities of the producer have a positive influence on the trade.

In the subsystem 3 "inventory and order system" the stock-keeping policies and the order attitude of the dealers due to the new product are shown. The acceptance of the product to take it into their assortment will strongly be influenced by subsystem 2 "supplier structure". For filling up the relevant stock, further informations concerning the supply on the producer's part (subsystem 5) become necessary.

In the subsystem 4 "order performance" the detailed strategies of supply of the orders of firmly decided buyers are simulated. The endogenous input into the subsystem are on the one hand the real monthly buying intentions (subsystem 1), on the other hand the acceptance of the trade, measured in the readiness to reorder the product for the customer (subsystem 2). Further input variables are necessary from subsystems 3 and 5. Subsystem 5 describes the production sector of the company with the administration of the ordering process.

With the grown spectrum of use it had become necessary to extend the model by evaluation systems in order to enable a comparison of alternative strategies, also with a view to the product rentability (profit and loss account). For this purpose the enterprise's cost accounting system was integrated into the existent model as a independent subsystem. As a result of the modular construction this was connected with a very little coupling effort.

The objective of optimizing the marketing strategies is to offer optimal control over sales and return of investment of the product, which are the variables of the state vector $z(s, t)$. The variables of control vector are defined by price, marketing budget and degree of product distribution.

With this methodological extension the development of an optimal, time variant marketing-mix strategy is performed by the computer.

1.1.4 Some critical remarks

The above described three applications developed in and with well known companies demonstrate the pragmatical use of this approach.

But the general, very important question in this context is what is the amount of improvement concerning the global optimization of system dynamics models to the quantity and quality of information as essential inputs of real decision situations.

Without going into much detail of the discussion of this question the most important criteria are the quality and validity of the model e.g.

- the closeness of reality of the model, similarity of model structure
- the quantity and quality of the data of the real system and its environment.

The result of this investigation (- we are performed -) can be made that the global optimization of system dynamics models describing technical or management problems can be recommended.

But the end user should always be conscious about the fact that the optimization algorithm (s) takes the corresponding model as a formal system and defines the optimal control-variables due to objective criterias independent of the congruence of the model and the real world. Without concerning about the above mentioned critical points the global optimization of dynamic models is only a scientific toy.

2. Partial Optimization

Following our statements we made in chapter I the partial optimization can simply be described by the integration of system dynamics and linear programming models. The attempt to explain some conceptual aspects shall be described as follows:

"The structure of rates, which determines the rules for transforming decisions into actions, can be described by four components: the desired value of the "policy statement", the actual condition, the deviation of apparent and desired condition and the corrective action. Rates are decisions which initiate certain actions according to given rules within specifically defined policies. A decision is made in accordance with an objective function towards which the system should move. Desired state often differs from the apparent state of actual conditions.

As a result of this discrepancy, the rate will initiate an action in order to eliminate the deviation. The fact that the LP-program will establish an optimal value for a rate implies special consequences for the system dynamics philosophy. The LP program's secondary requirements describe in detail problem stages (partial problems) and compute the optimal value for this partial problem. The delivery of the optimal value to the rate at any point of time t_1 results in the action initiated by deviation being optimal.

The outlined combination rate-LP program thus represents optimal behaviour of the real system.

Two practical examples of the partial optimization are described in the chapter (III.2) focussing on the integration of system dynamics and econometric approaches.

III. Econometric Approaches and System Dynamics Models

1. Introduction

In this context most of our interest focuses on the integration of System Dynamics and Input-Output models. But as already mentioned before the two comprehensive projects which will be discussed in detail involve two essential linear programming models as examples for the partial optimization. The project "Model Chemical Industry" founded by

the German Government is concerned with the supply of raw material for the chemical industry. Another project founded by the German research foundation describes the planning process of innovative investments of the machine building industry.

2. Two practical Applications of the Integration of System Dynamics, Linear Programming and Input-Output-Models.

2.1 Model Chemical Industry

2.1.1 Introduction

For the investigation of problems concerning the supply of raw material the German government has promoted a model project¹⁾ which shall support the decision maker in finding the best R & D strategies in the chemical industry with respect to a modified supply of raw material. The model will simulate the next 25 years (see Fig. 7).

Two essential questions should be answered by the model:

- Which technological and economic processes of adaption are necessary to react efficiently on an assumed price development at the raw material market and/or on a modified supply of raw material?
- Which importance do process and product innovations have, developed in the course of an investment program in order to overcome critical raw material shortages and/or in order to realize the saving of raw material?

1) Model Chemische Technik/Vorstudie vom Institut für Angewandte Wirtschaftsforschung (IAW), Tübingen, vom Industrieseminar der Universität Mannheim (ISM) und vom Institut für Systemtechnik und Innovationsforschung der Fraunhofer-Gesellschaft (ISI), Karlsruhe, im Auftrag des Bundesministeriums für Forschung und Technologie, Juni 1976.

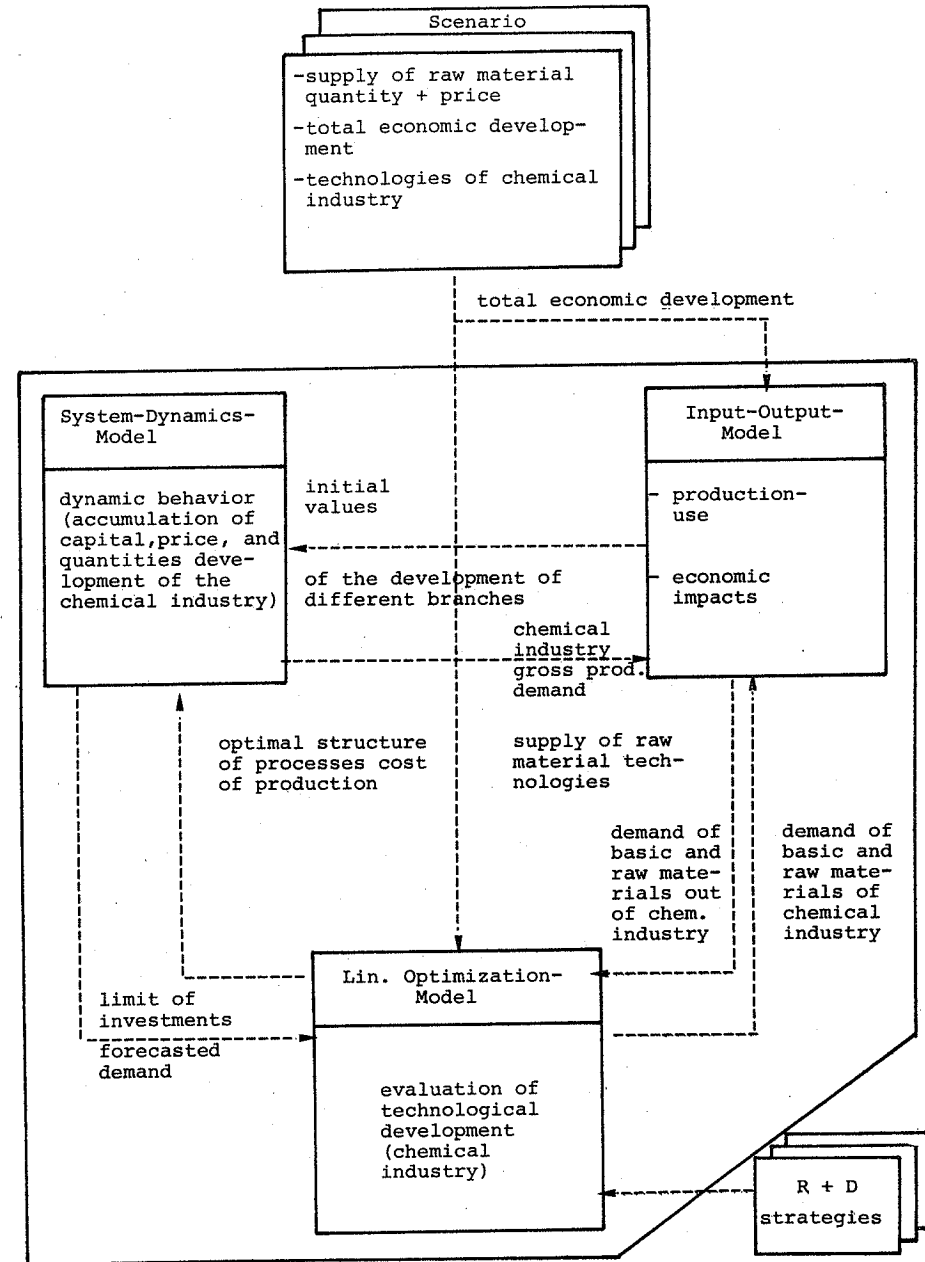

Fig. 7 : Basic concept of the total model

The over-all problem causes the requirement to analyse the technologies (production structures) and their development of this sector of economy and to present it in a model (Kornprobst and Pfeiffer, 1976).

Because of changing costs of production it is necessary to integrate the market behavior for the corresponding products into the simulation model. Important macro-economic variables, as demand of sectors for primary inputs, price relationship etc. had to be taken into consideration based on the total economic constellation and the development of the Federal Republic of Germany (FRG). Concerning the complexity of these questions the requirements at the methods of the total model are:

- description of the total economy and consistent embedding of the sector chemical industry (input output model),
- dynamic description of the cause-effect relationships of product demand and investment behavior of the sector chemical industry (System Dynamics),
- description of the technological development of production process inside the sector chemical industry (linear optimization model).

Because a comparable study had never been realized it was necessary to test the effectivity of such a project at a destined production sector of the chemical industry, the organic basic materials, synthetic materials and synthetic fibres and threads.

2.1.2 Submodels

2.1.2.1 The Input/Output Model

The I/O model describes the total economic activity which includes as well all economic sectors of the FRG as described some parts of the chemical industry in all details. The principle of this disaggregation corresponding to the

relevant raw material was based on macroeconomic tables of the Deutsches Institut für Wirtschaftsforschung (DIW), which used the institutional principles for sector building thus having the firm as the basic statistical unit. The quantification of intersectoral activities was made with the help of experts, official statistics, statements of unions, and own calculations.

The basic component of input-output analysis is the design of the input-output table according to which empirical data are collected. An input-output table assigns the collected data to individual production sectors. The table, therefore, offers an insight into the economic production structure which cannot be had by any other statistical tools. Input-output tables describe flows of goods and services between individual sectors of economy.

Reading a table by rows it can be determined how much a certain individual sector delivers to other sectors. In this way, some elements of the first row indicate how much the first production sector delivers to itself and to other sectors. Other elements of the first row indicate deliveries to final demand sectors i.e. private households, government, investment (capital expenditures and inventories), and export sector. The deliveries to the production and final demand sector depict, by definition, the total production of the first sector and also by definition total demand for the products of the first sector. The columns of the table give the demand by each sector for deliveries or services of other sectors which by definition is put equal to the transfers it receives from other sectors. Reading the table by columns reveals the transfers which the individual sector receives from other sectors (inputs). Included in the so-called primary inputs are imports which among others include foreign raw material deliveries. The remaining primary inputs show the amount of capital depreciation, the remuneration of labour and capital.

One problem in this model is to generate the I/O table (56 x 56) for future points of time. Some data can be got by the scenarios, which deliver possible alternatives of the economic growth and the simulation of raw material. From the SD model, the I/O model will get future data of the gross production and the demand of the chemical industry.

The LP program delivers informations about the demand of basic and raw materials of the chemical industry. With the application of a mathematical procedure called MODOP the rest of data is computed. The quality of this projection method was determined with statistical data by performing an ex-post simulation from 1958 to 1972 and comparing the actual with computed data.

2.1.2.2 The Linear Optimization Model¹⁾

The main task of the LP model is to compute the technological development of the chemical industry as a function of changes in price and shortages in raw materials (Burger et al 1976).

By determining a demand function with reference to the development of the particular branch and its long-termed tendencies, future quantities and prices of products of the chemical industry can be found out. This estimated demand, besides the investment plan, the demand for raw materials and preproducts of other branches delivered from the I/O model as well as the prices of raw materials and changed technologies from other scenarios, serve as a guide line for calculating the process structure with the minimum cost.

The basic structure of the LP model is shown in fig. 8.

The production of the final products occurs from different raw materials, basic materials and preproducts. The total flexibility of this branch of production is shown by the fact that as well the final products can be produced by

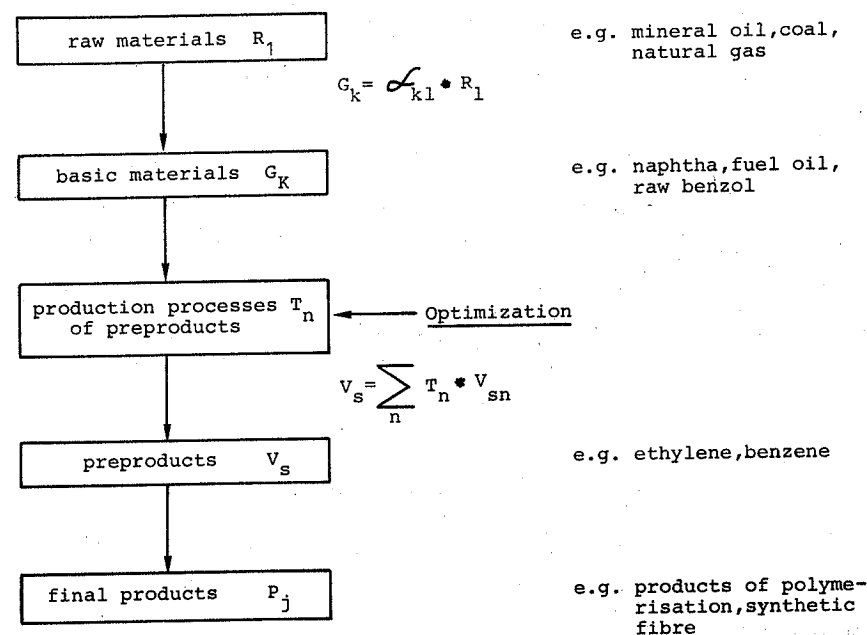

Fig. 8: Basic Structure of the LP model
(Source: Modell Chemische Technik (1976), p. 5-2).

1) This is the first practical example to the chapter II.2 partial optimization

different processes of different preproducts as these preproducts can be manufactured by different processes of different basic materials. Each possible way of production causes different costs of production. Under the assumption to produce with minimal costs as main criteria, the LP-model computes the optimal technological development of production processes of the chemical industry.

2.1.2.3 The System Dynamics Model

In the SD model particular attention is given to the process of capital formation which involves capacity employment and depreciation. On this basis, fixed costs can be calculated, which - together with the variable production costs calculated in the LP model - are used to form a supply function.

The System Dynamics model consists of the essential sectors:

- the capital and capacity sector,
- the market sector.

With a time interval of four years the SD model calls the LP and I/O model. Data for the formulation of the objective function and for the description of the boundary conditions are delivered to the linear programming model, which for its part gives information about the optimal structure of production processes and about specific product costs. Fig. 9 and Fig. 10 describe two main relationships between the SD- and LP model.

The optimal capacity data of the preproduct production processes represent the desired values for the main feedback loop realized in the SD model. The first loop structure describes how the optimal value of capacity computed in the LP program is realized within the four years optimization interval (see fig. 9). Another, very essential integration of LP and SD model becomes obvious with the production of preproducts (see fig. 10).

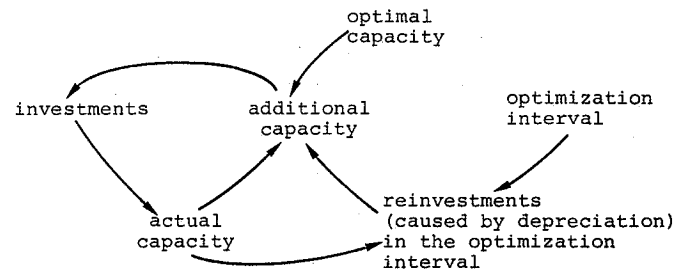

Fig.9: Causal structure of the investments of the preproducts (Source:Modell Chemische Technik (1976),p. 4-6)

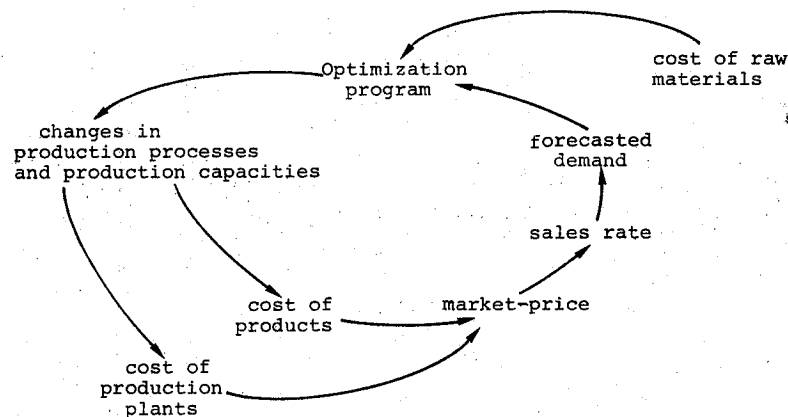

Fig.10: Causal relationship between the demand with the optimization program (Source:Modell Chemische Technik (1976), p. 4-9)

This model overlapping feedback describes that an increase of raw material or other production cost leads to structural changes of the technology mix. Thereby the costs of preproducts are changed which are concerned by the modifications of processes.

In the SD model the capital building process is formulated in the same sense as the production processes are selected in the LP model: The capital is invested and depreciated gradually or capacities respectively are reduced or eliminated with time. The capital formation process - once started - influences the production costs with its typical time lags then again has an effect on demand and production.

In this case for every considered production method an extra capital and capacity vector is formed, which is subdivided into age-groups and others. A further subdivision is formed with respect to the time.

The construction of capacity and capital vectors facilitates finding out the correct production costs, even if capital is fully or partially depreciated, because the lifespan and the period of depreciation of plant can vary.

2.1.3 The Total Model

The total model was simulated in an ex-post projection from 1958 to 1972 and the results were compared with the reality. These results can be considered as satisfactory with respect to non sufficient data base (see fig. 11). Fig. 7 shows a survey of the interdependent relations of the total model. The simultaneous model-method-linkage represents a new area in the methodical and model technical sense. The arising difficulties require essential consequences in the future work in the area of model coupling. The definition of interfaces is a basic prerequisite of an integration of different model types. Such a definition includes not only the number

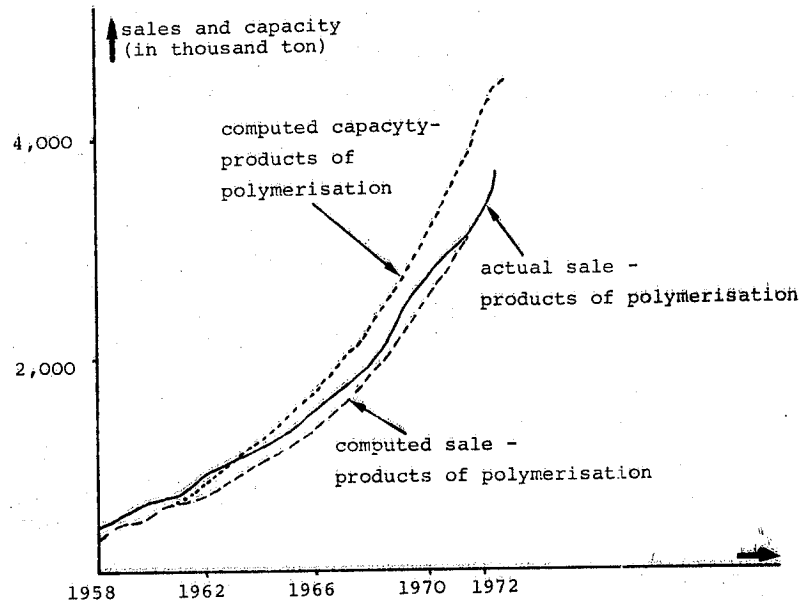

Fig. 11: Sales and capacity of products of polymerisation (Source: Modell Chemische Technik (1976), p. 4-25)

and the type of variables but also the dimension and the scale factor of the concerned size. Disregard of these restrictions leads to difficulties when the SD- and LP-model are brought together with the I/O model regarding the valuation of quantity streams.

The valuation at cost prices in the LP model (SD model) must be made consistent with the valuation at ex-works-prices in the I/O model.

Because of the different model concepts of System Dynamics (dynamic) and the Linear Programming (static), difficulties can arise in the timing of the coupling. The optimal capacity fixed in the LP model should be realized in a four years optimization interval by the SD model (that means that the coupling is executed in a time interval of 4 years). This model coupling as a function of time is a problem in the sense that for example for profitability of the Chemical Technique could change within one projected interval of two optimization moments. This includes the risk of the optimal operation structure of the LP model becoming invalid. The following coupling concept shows an alternative to this time dependent coupling and also a solution to the problem: the control of the call of the LP model is carried out with regard to defined boundaries that means, if the profitability changes in a way to disturb the lower and upper conditions, there is a new call of optimization. This concept burdens the central processing time, but enables additional informations.

2.1.4 Summary

At this moment, the total model with its already relative complex submodels (Input/Output-, Linear Optimization- and System Dynamics Model) represents the first step in solving the problems of a technology assessment with respect to overcome critical raw material shortages and to realize the saving of raw materials.

Such a model-method-integration is an instrument making plain how to deal with complex and comprehensive socio-economic phenomena in an easier way. After further experiences with the practical model application and after methodical improvements, an instrument should be created which will fulfill also the requirements of practice. It is hope that further experiences with the practical model applications and the methodical improvements would create an instrument which would fulfill also the requirements of practice.

2.2. Model for planning innovative investments of the machine building industry

2.2.1. The problematic nature and the process of development of the innovative investment planning in the machine building industry

This study deals with investment planning in providing of new equipment to small and medium size companies in the machine building industry, whereby an exemplary investigation of the application of the NC-technology was performed and the analysis of more complex automation (a computer based job planning system and a flexible system of production manufacturing) has been started.

The automation of limited quantity production of machine building industry is characterized today by a conversion process towards growing computer based applications both in material processing and transport as well as in the planning phases construction, operations scheduling and manufacturing control. If from the technical standpoint individual processes and elements of the manufacturing process are to be automated the task of the investment planning consists in conducting a critical report of the efficiency.

The problematic nature of such an investment decision can be outlined as follows:

- the introduction of certain production equipment is linked to complicated and expensive technical/organizational processes of adaptation;
- the production equipment determines in long range the potential manufacturing program of a company;
- the production equipment of the above mentioned industry requires a considerable amount of capital;
- the question of financing of such investment projects has great importance for the company;
- in planning of automation processes of limited quantity production for firms of machine building industry, the consequences of different strategies must be investigated concerning the objects of investments regarding the financial, personal, organizational and social effects.

Because of the interactions between company and its environment next beside to the internal aspects, macro-economic components are never-the-less important determinants of innovative investment planning.

The description of strongly differing aggregated variables, for example the representation of the global demand on the one hand and the detailed analysis of the coordination of capacity on the other hand, cannot be realized by a comprehensive macro-economic model.

Such a differentiating level of aggregation requests a hierarchical-structured model system with an interdisciplinary concept, which places the essential - the necessity of a best possible possible solution of the problem with appropriate techniques - into the foreground (Krallmann 1979b). On the basis of these conclusions, the macro-economic area is represented by an Input-Output model. A linear programming model and a System Dynamics model describe a representative firm of the machine tool building industry to outline the operational and internal consequence of an innovative investment in the manufacturing area (see fig. 12). The three-level-model-method linkage on the one hand contributes to the improvement of the transparency of the total system, and

on the other hand it succeeds in meeting the requirements of the validation - even if only to a small extent.

2.2.2. Linear Programming Model¹⁾

Principal item of this model linkage is a coupled System Dynamics and Linear Optimization model (SD-LP model). The SD-LP model optimizes and simulates the investment activities of a representative firm of the machine tool building industry. The LP model fits-at the computed sales development by the I/O-model - the investment and financial planning as optimal final value, while the SD model simulates the company internal processes and the consequences of this adaptation in detail over time.

In the optimization model the principle of "rolling planning" is applied. The planning period comprises thereby respectively 24 months, that is, every 24 months, the LP-model is called to establish new data. But the LP-model surveys 72 months and delivers only the actual value for the first two years to the SD-model, so that a data overlapping period of 48 months exists. The planning horizon of the complete model is defined with 8 - 10 years. The financial restrictions appear as significant secondary conditions: investments borrowing and withdrawals are variables to be determined in each period from "t" to the planning horizon "t + Q" in compliance with

- the financial balance between installments, pay-offs, and cash balances during production and sale of the given output
- a capital dependent limit of credit
- a production capacity in the areas of drilling, lathe tooling, and milling which is sufficient for the given output.

The final amount of capital due to the planning horizon consists of

1) This is the second example to the chapter II.2 partial optimization

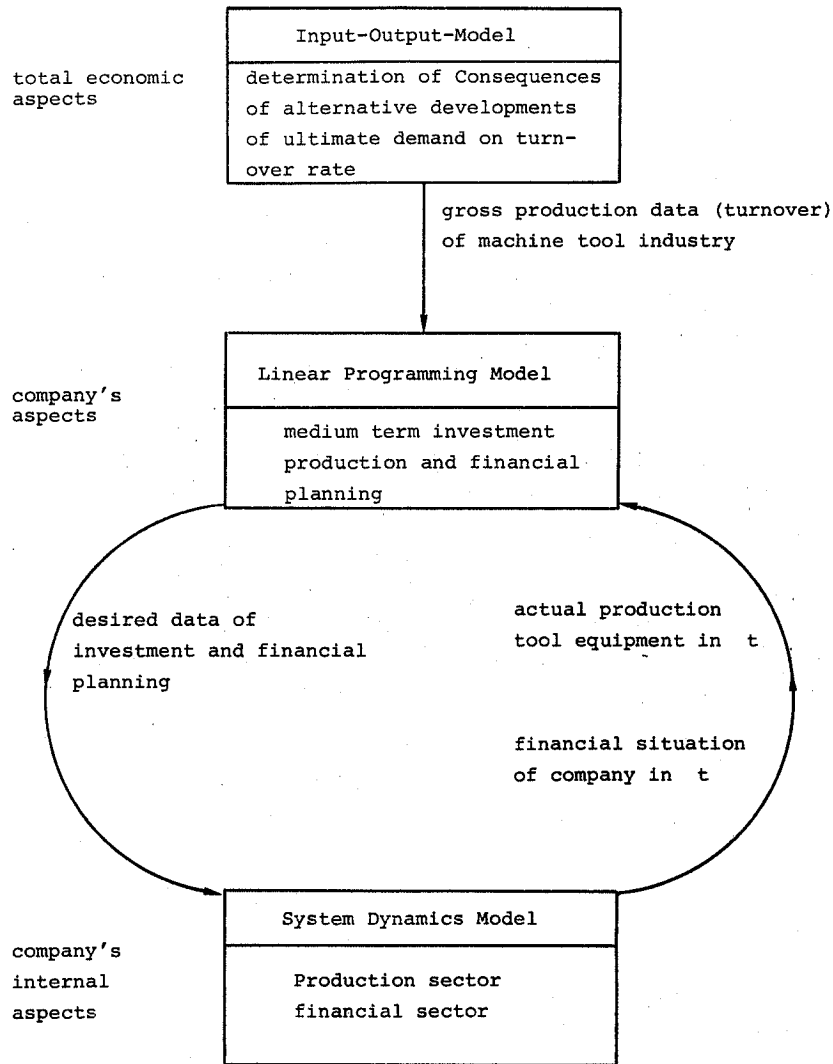

Fig.12: Structure of the three step Model linkage

- the capital on the horizon at liquidation prices,
- cash balance on the horizon,
- the withdrawals (in the planning period) computed including the interest at the horizon, subtracting the not yet payed credit debts is to be maximized.

The remaining system of restrictions, which consists of capacity and equipment equations for the limitation of the present alternative attainable production equipment guarantees that sufficient installation capacity is available (in each planning period), in order to produce the demanded output.

2.2.3. The System Dynamics Model

The System Dynamics model transfers the delivered objective variables of the LP-model in respect of time to short-term dispositions and calculates the resulting consequences in the area of finance and production over the time. The System Dynamics concept is used as a method for the representation of the structure and the parameters. The variables for organizational levels in the workshop and the job planning system form the basis of the model.

2.2.4. Input-Output Model

The expected sales in the machine tool building industry are considered as an essential decision criteria regarding this investment planning process. In order to show the process of implementation of the NC-technique in this sector, the SD/LP model is enlarged by an Input-Output model (I/O-model). It is an open static I/O-model, which has been expanded by a dynamic model of the demand for investment goods. On the entire model concept the I/O-system has the task to show the effects of alternatively given developments of the final demand for products of any sectors (for example airplane)

manufacturing, the manufacture of motor vehicles and ship building) upon internal demand for investment goods in the machine tool building industry. This formulation of the problem has the advantage, in comparison to an isolated observation of the development of sales in a single sector as the basis of investment planning, that micro-economic foundations of decision are taken from a macro-economic background. Alternative developments for the components of the final demand are supplied by the user so that the diffusion of the NC-technology in the machine tool building industry which results from that can be determined.

2.2.5. The Presentation of the Results of the Model Integration

In order to demonstrate the way in which the model integration operates the data of a representative firm of a machine tool building industry with a size of 400 employees with a 25 million turn-over per year were used. Fig. 13 shows the resulting development of the absolute number of NC machines of the representative firm.

The graph illustrates the consequences of the differing development (optimistic, pessimistic) of the final demand to the introduction of the NC-technique in that company. The simulation period is six years. When the market development is favorable, eleven NC-machines are installed after six years, when it is unfavorable, only eight NC-machines are installed. The development of investments at the standard prognosis at the end of the planning horizon computes nine NC-machines. A realistic interpretation of these results shows that, when demand decreases furthermore at a limited extent only replacement investments are carried out. The time difference of 3 years (see fig. 13) between the introduction of the eight NC-machines into the firm with an optimistic versus pessimistic demand prognosis documents the influence of different market developments due to the realization of the technical progress in the production process of machine tool building industry.

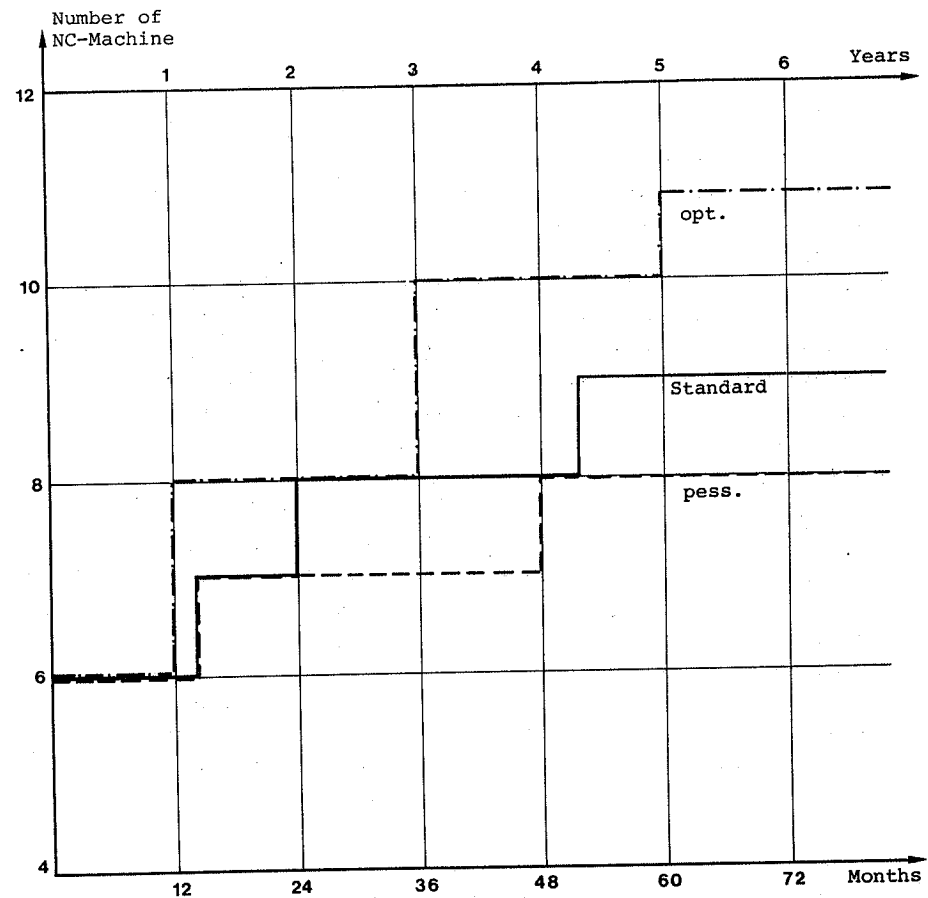

Fig.13: Development of the NC-Technique in special company different Market behaviors

The positive results of the discussions of the realized three level integrated model system motivated for an analysis and evaluation of more complex automated production equipment as in this case investigations of computer based systems of job planning and flexible production systems (Krallmann 1979c) had been performed. Both projects, which are carried out in close cooperation with two companies led to major changes in model structure and to the application of a dynamic programming model.

In order to present such measures of automation in combination with one another, the instrument of linear programming is no longer sufficient because of the appearing essential non-linear impacts. Especially the instrument of dynamic programming proves itself to be very promising. An intensification of the interactions is aimed at the model of dynamic programming and the Input-Output model. The essential point consists in the realization of a bilateral transfer of data between both submodels.

The transfer of data describes on the one hand a sales forecast into the model of dynamic programming and on the other hand a forecast of investment planning and investment demand into the Input-Output-model.

3. Some Critical Remarks

Input-Output analysis is a mechanism for depicting a complete economic structure. Transferring the values of the Input-Output table on to the auxiliaries of a System Dynamics model, as e.g. the so-called input coefficients of the Input-Output table are assigned. The input coefficients,

$$a_{ij} = \frac{x_{ij}}{x_j},$$

are calculated for the production sector. They show what quantity of product i sector j is used to produce one unit of output j . The input coefficients, and therefore the corresponding auxiliaries, can be interpreted as technical variables or quantitative market variables which characterize the production structure of the economy. The advantage of combining System Dynamics with Input-Output analysis is that the degree of reality is now incorporated in the System Dynamics model.

System Dynamics, Input-Output method and Linear programming are well approved tools and successfully applied to different problems. But using these approaches in an integrated system there are some critical facts which may not be kept secret as e.g.

- the handling of the total model complexity
- high requirements are set to end users in handling these different methods
- high data processing requirements are very evident.

The expenditures of these facts and of others in comparison to the benefits must decide about the application of such an integrated system.

IV. System Dynamics Models as Decision Support Systems

1. Introduction

This chapter describes the further development of the project "Introduction of innovative Products into a competitive Market" (see in this context the chapter I. 1.1.3 which describes the problem in some detail) towards a model base system.

The management of the company we worked together wanted to get support in the decision making process of introducing innovative but similar products into a competitive market. These different products for sterile (pure) water processing

- are based on the same idea of performance but different attributes (or properties)
- are of high quality
- use the same logistic
- operate in different markets.

Based on the two already developed System Dynamics models for two different products (see Krallmann 1980b), the idea was born to create a model base system. In the first step this model base system should contain

- a number of submodels (modules) describing different sectors of different real systems
- a number of optimization routines (razor search, evolution strategies and other heuristic search algorithms)
- a planning language beside general statements which can handle the modules and algorithm routines with user friendly commands and which takes care of the execution process on different computers.

The second stage is to design an interface between the model base system and a data base system to get access to company's internal (e.g. cost accounting system) and external data. This step is now in the phase of design.

The planning language now under development can be characterized by interactive, flexible, transparent and user friendly. Further on the surface of this language is easy to use, reliable, reasonably self-explanatory, and responsive - just like a staff assistance. This points out an important conclusion: management wants to become directly involved in the model building process so that they may understand it and so that the model has credibility.

Another major additional change had to be performed at the DYNAMO-Compiler and its produced FORTRAN-Code.

Special software has been developed to present the results from the simulation models being investigated and data of the cost accounting system in integrated figures (in any desired arrangement of rows, columns, and headings). Report formats may be called from storage or specified as needed.

The main advantage of such a decision support system (model base system + planning language + report generator + data base system) consists in the fact that the manager can formulate and simulate very easily his own problems based on System Dynamics in this specific field at this time.

The requirements at decision support systems caused by growing problem complexity and organizational structure demand in the process of man machine communication the support of human inabilities as

- human memory through data base systems
- simultaneous consideration (analysis) of complex facts (problems) through model base systems.

These tools can give an important support to human capabilities as creativity and association of ideas.

2. Components of the DSS

2.1. Command and planning languages

The conversational language between decision maker and machine should comprise linguistic elements and integration rules which follow the expert languages of the decider in mnemonic technical respect. The user surface of this language "must be flexible, easy to use, reliable, reasonably self-explanatory, and responsive - just like a staff assistant" (Keen 1980 , P. 41). If possible, the command language should be nonprocedural for supporting a thematic classification of the model structure in respect of the model building (see Keen and Wagner 1979 , p. 119).

For a future orientated DSS a user friendly control system (also called method monitor) for the realization of complex program systems will be evident. The final user can integrate methods to parameterless procedures which can be established by a simple command language. The procedures are registered in a relevant file and are called with their names. Such a structured control ensures for the user an excellent combination of the methods without establishing a program.

Beside the process of model building and of program realization the phases of alternative finding and evaluation are to be realized computer supported. The procedures which always repeat in situations as alternative evaluation can be simulated by special simple commands. A "what-if" command allows after input of the strategy which shall be analyzed the automatic output of the results of selected objective variables in relation to the defined standard run. For supporting the alternative finding in the case of a planning with defined objective variables, the generating of a "goal-seeking" or "what-to-do-achieve" command is recommended which describes the planning measures to be performed in order to achieve a certain objective (see Wagner 1980 , p. 210). The evident

demand of the interactive equipment of the command and planning language (of the DSS) can at every time be argued as follows:

- direct use of the DSS by the decision maker
- considerable enhancement of efficiency by immediate reaction in group conferences and
- positive influence on the creativity and intuition of the decision maker (see Vazsonyi 1978 , p. 76; Keen and Wagner 1979 , p. 119).

An extremely comfortable handling of the unformatted data input up to normalized output routines, e.g. for tables and histograms, is a necessary request for the use of the system by the decision maker. He is an expert in the scope of application and disposes only of basic knowledges of the methods, he needs, however, explanation and decision supports for the efficient operating because of his limited know-how of EDP.

In this special project for the handling of the modular System Dynamic model and the methods of heuristic optimization in the process of global optimization we developed a userfriendly interface part. The interface part is very reliable, easy to learn, self-descriptive and flexible in task handling. A communication part realized in this manner enables end users with different know-how (EDP training etc.) and different professional career to use the computer aided DSS, by having realized first steps of the interface part with a view to individual adaptability (see Fig. 14).

2.2. Data base system

Under the point of view of an extension of the possibilities of application of data for many different applications as well as for many different users the storage must be transmitted from the so far usual orientation on a special application to a general data orientation. The increasing data application on higher decision levels in the case of problem solutions

```

(OUT) YOU ARE IN SEGMENT:
(OUT) TEXT
(OUT) DO YOU WANT FURTHER RESP. REPEATED INFORMATION:
(OUT) ANSWER (Y/N)
(OUT) OR DO YOU WANT TO SKIP: ANSWER (C,<SEGMENT>)

(IN) Y
(OUT) YOU HAVE THE POSSIBILITY TO OPTIMIZE CERTAIN VARIABLES
(OUT) OUT OF YOUR ALREADY DEVELOPED SIMULATION MODEL BY MEANS
(OUT) OF AN OPTIMIZATION PROCEDURE (FURTHER ON CALLED OPTPARMS).
(OUT) FURTHERMORE YOU CAN OBTAIN STATE VARIABLES OUT OF YOUR
(OUT) MODEL (FURTHER ON CALLED ZUPARMS), WHICH YOU CAN USE IN
(OUT) YOUR OBJECTIVE FUNCTION.
(OUT)
(OUT) EXAMPLE: OBJ.FUNCT.=WEIGHT1 * ZUPARM1 + WEIGHT2 * ZUPARM2
(OUT) YOU ARE GUIDED IN THIS INTERACTIVE PHASE OF THE OPTIMI-
(OUT) ZATION BY QUESTION AND ANSWER. IF YOU ARE IN A TEXT PART
(OUT) (LIKE NOW) THE SIGNS *+-O APPEAR FOR TURNING OVER.
(OUT) + OR * MEANS TURN OVER ; - IS TURN BACK ; O FINISH
(OUT) THE TEXT.
(OUT)
(OUT) *+-O
(OUT) *
(IN) *
(OUT) YOU ARE IN SEGMENT:
(OUT) TEXT
(OUT) DO YOU WANT FURTHER RESP. REPEATED INFORMATION:
(OUT) ANSWER (Y/N)
(OUT) OR DO YOU WANT TO SKIP: ANSWER (C,<SEGMENT>)

(IN) N
(OUT) YOU ARE IN SEGMENT:
(OUT) EPROC. COMMON
(OUT) DO YOU WANT FURTHER RESP. REPEATED INFORMATION:
(OUT) ANSWER (Y/N)
(OUT) OR DO YOU WANT TO SKIP: ANSWER (C,<SEGMENT>)

(IN) N
(OUT) ENTER THE VARIABLE LIST, SEPARATED BY COMMATA,
(OUT) MAXIMUM THREE DISPLAY LINES (80 SIGNS EACH) !!!
(IN) A1, A2,A3,A4,A5,A6,A7,Z1,Z2,Z3,Z4,Z5
(OUT) A1,A2,A3,A4,A5,A6,A7,Z1,Z2,Z3,Z4,Z5
(OUT) WAS THE ANSWER CORRECT? : ANSWER (Y/N)
(OUT) OR DO YOU WANT ONCE AGAIN THE EXPLANATION ? : ANSWER (R)

(IN) Y
(OUT) PLEASE WAIT !!
(OUT) E N D COMMON
(OUT) YOU ARE IN SEGMENT:
(OUT) EPROC.OPTPARM
(OUT) DO YOU WANT FURTHER RESP. REPEATED INFORMATION:
(OUT) ANSWER (Y/N)
(OUT) OR DO YOU WANT TO SKIP : ANSWER (C, <SEGMENT>)

(IN) N
(OUT) THESE ARE ALL YOUR POSSIBLE VARIABLES
(OUT) A1,A2,A3,A4,A5,A6,A7,Z1,Z2,Z3,Z4,Z5
(OUT) PLEASE ENTER FIRST THE NUMBER AND VARIABLE LIST
(OUT) SEPARATED BY COMMATA, MAXIMUM 10, MAXIMUM THREE
(OUT) DISPLAY LINES (A 80 SIGNS) !!!

```

Fig.14: Computer supported communication part

which go across functional and organizational limits recommends the development of a data architecture plan for processing the concentrated information requirements of the enterprise. The development in the data management can be characterized by an

- increasing storage with direct access in the case of decreasing costs and increasing capacity
- data structuring with the capability to describe more complex data concatenation.

Thus the data base system becomes a necessary condition for a strategic DSS. The transition from data files over data file administration systems up to data bases considers the importance of the data as a basic auxiliary for decision functions. Data bases have been created for the following reasons:

- The flexibility of the different applications resp. data applications should be supported and not prevented.
- The redundant storage of similar data should possibly be prevented.
- The security of the data should be given by a consistent data base.
- User programs should become independent of the physical data organization.

In this special project we use the company's data base system to get access to the data of the cost accounting system.

2.3 Model/Methods base system

As a second essential component of a strategic DSS, apart from the data base system a methods/model base system is required with the function to support the decision maker (model builder) in the phase of modeling, i.e. of representing the real problem to be solved in quantitative termini by farreaching standardized, often required, procedure appropriate program units (see Hauer 1979 , p. 262).

A methods/model base system is composed of

- a file of preproduced and documented program elements (methods base system); these can be derived from existent method base packages of the producers or can be supplied by the final user himself
- a file of preproduced and documented model modules
- a method monitor (control system) with a data administration, a formula interpreter, a data base connection and procedures for integrating user own programs as well as
- software components for the user friendly support (i.e. choice of methods, interpretation and representation of methods, results of methods etc. (see Gernert 1979, p. 94 ff)).

In this special project the developed model system was classified into five functional submodels with the intention to reuse it for sequence products with the same distribution structure (producer - trade - final user). The standardization of these subsystems (e.g. subsystem 4 - execution of order by trade) was effected under the points of view of larger modification tendency and modular extension. The result is represented in fig. 6 as a basic structure of the model (see in this context the chapter I. 1.1.3 which describes the submodels in some detail).

3. The integrated concept

The DSS for the time being in the process of investigation and development are characterized by the integration concept with the essential functions data manipulation and model building which have been so far represented in the scope of data and model base systems (see Wagner 1980, p. 200). The realization of an efficient strategic DSS needs the integration of the functions "data handling" and "modeling" in the case of mutual direct involvement of the end user. Out of this fact three critical interfaces result which have to be got under

control by the software of a DSS (see Bonczek, Holsapple and Whinston 1980, p. 345) on the one hand by the transfers between the system components data base and methods/model base with regard to the user, on the other hand by the system internal interactions of data bases and methods/model base (see fig. 15).

In this special project the decision support system for the "Introduction of innovative Products into a competitive Market" is based on four essential components (see Fig. 16):

- the model base system with the System Dynamics modules established by the user in the simulation language DYNAMO
- the monitoring system with the essential part - EDT procedure "SHOOT". The data file processor EDT is a user oriented dialog text editor which modifies the FORTRAN code of the SD model generated by the DYNAMO III/F-compiler. The modified FORTRAN subroutine can then be linked with other modules and can be integrated into the global optimization process
- the method base system for the optimization routines and the modules for representing different objective functions
- the interface part.

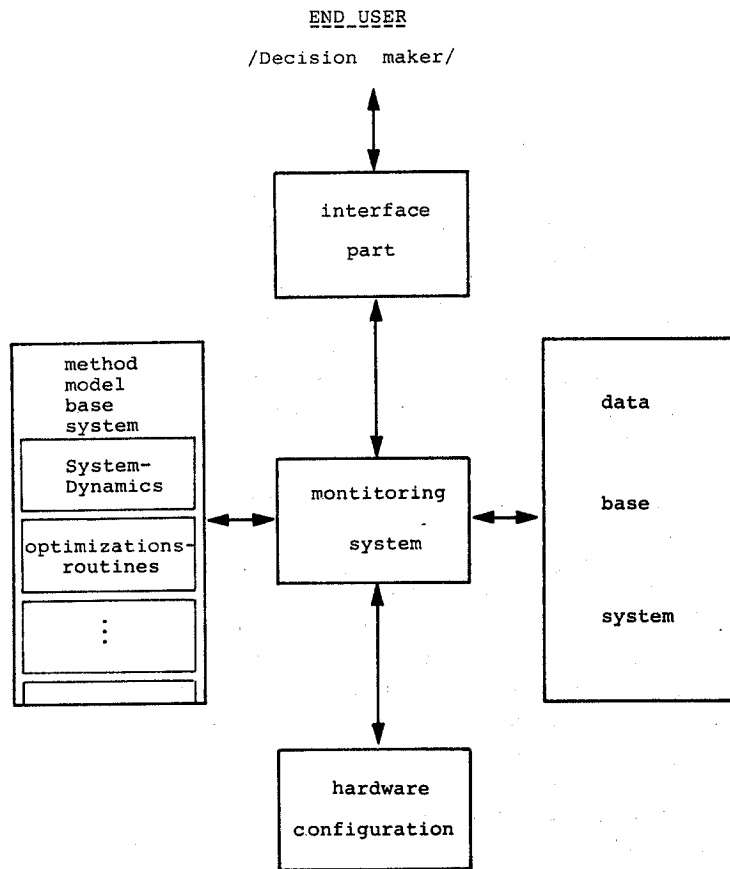

Fig.15: Decision Support Systems

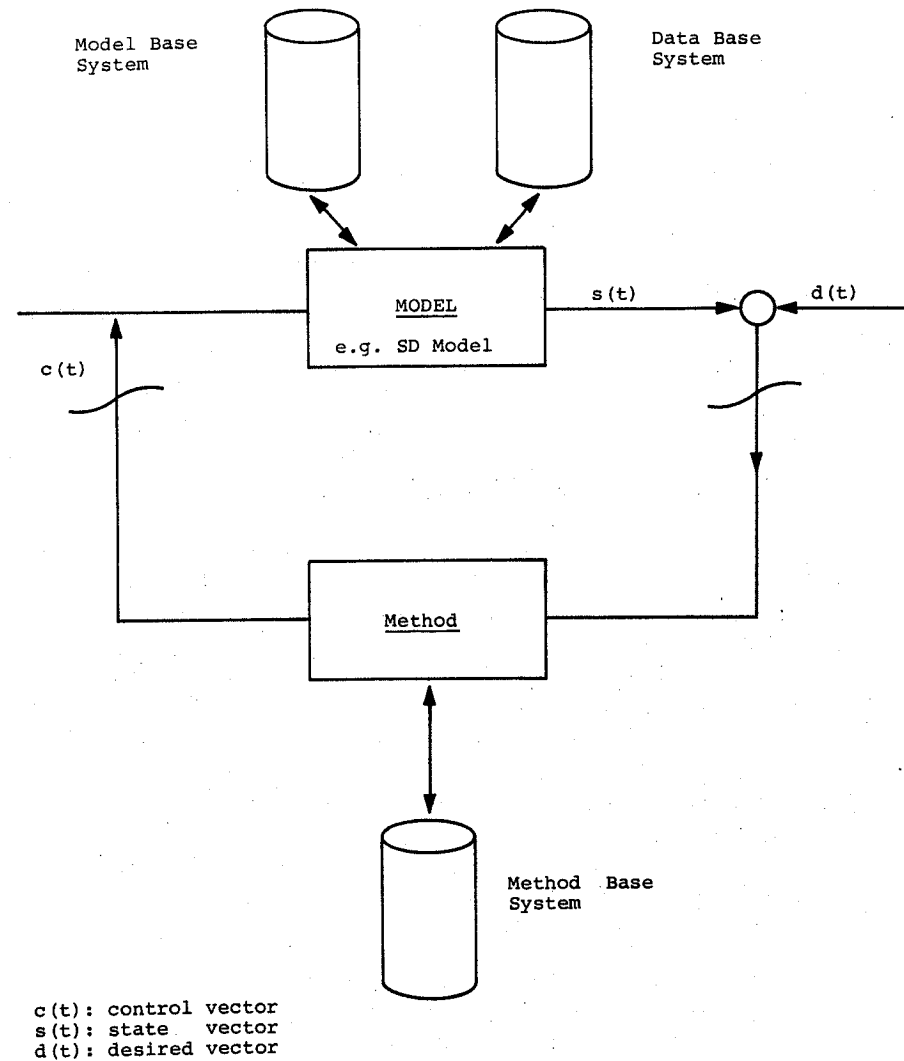

Fig.16: Total System Configuration

The interface part serves the absolute priority of the realization of a user friendly, computer supported planning system (see also chapter IV.2.1.). The integration of the end user, the reduction of his acceptance problem by a user friendly interface part, which is on the one hand extremely robust and on the other hand easy to learn, were the central points of this software development. The easiness of use and the minimal EDP specific know-how are demonstrated by the computer supported dialog in the interface part (see fig. 14).

In principle, only the following informations are required of the end user:

- Number, name and restrictions of the control variables
- Number and names of the state variables
- Specification and parameters of the objective function
- Declarations regarding the simulation/optimization variants
- Choice of the optimization algorithm and the relevant parameters (documented in a self-explanatory manner).

4. Some Critical remarks

For judging the presented DSS the criteria by Sprague and Watson 1975 , p. 35 ff., shall be taken:

- Collection of modular models for support in different functional fields and on different management levels;
- Modular model elements which are transferable single or in any combination;
- Mechanisms for direct automatic data supply of models out of the data base;
- Common end user language for data handling and for model building resp. execution.

Critically seen, it must be said that with the DSS for the sales' planning of innovative products only proportional parts of the criteria of Sprague and Watson could be realized, but the basic conception as well as principle ideas could be performed.

Some experiences and understandings of these first phases of development implementation process can be summarized as follows:

- The application spectrum and the extension of the DSS should grow in a stepwise manner with the degree of maturity and comprehension of technology resp. of personal, i.e. only modules should be added which are applicable in technical, organizational and economical respect;
- development of the DSS and the implementation into an existent EDP system of the enterprise should be directly supported and realized in cooperation with the end user himself.

If the demand of the DSS is defined in the improvement of the efficiency of the strategic decision processes and in the connection of the qualifications of men and machines, there is still a far road to success.

V. System Dynamics Models based on the integrated approaches of ABRAHAM/ISAC and PETRI nets

1. Introduction

This chapter is quite different in comparison to the previous ones.

The previous chapters describe well-experienced approaches, implemented in well-known companies. In this chapter an integrated concept will be presented which is only applied to academic examples (Godbersen 1983). But this approach based on ABRAHAM/ISAC and PETRI nets is in my opinion very interesting because the analysis of structure and dynamic behavior of models can be performed by the mathematical calculus of the Petri nets. By doing this the validation process of model building can be supported and the attributes of the object system can be established.

2. Description of the selected approaches

2.1 ABRAHAM/ISAC (Lundeberg et al. 1979)

ABRAHAM stands for ABbreviating Activities HAndling Methods. ISAC (Information Systems Work and Analysis of Changes) is a research group at the department of Administrative Information Processing at the Royal Institute of Technology and the University of Stockholm, Sweden. Since 1971 research has been performed in the ISAC group around a new approach to information systems development with special emphasis on analysis and design of information systems (Lundeberg et al. 1979). This concept had been simplified from methodological point of view to get an interface to the Petri net theory. There are two kinds of elements:

Activities and information units (channels)/material units. These elements can be connected by arrows describing relations between the activities and the information units (see fig. 17).

An essential characteristic feature is the possibility to redefine and to abstract gradually the activities and information units. On this way a problem area can be described on different abstraction levels of refinement (see fig. 18).

All different levels can clearly be summarized by activity and information trees.

2.2 Summary of Petri net theory

A huge amount of literature is available describing the theory of nets and further developments and improvements. Petri describes the objectives of net theory:

"The theory of nets is a form of general systems theory, developed as a tool for the system analyst for representing and investigating real or planned information and communication systems in any required degree of detail. On the other hand, net theory constitutes an axiomatic approach towards establishing a conceptual frame for the description of the phenomena of information flow. This approach is similar in spirit, and to some extent influenced by the axiomatization of relativistic spatio-temporal structure which Reichenbach et al. undertook fifty years ago Petri 1973, p. 137. Later on Petri introduced a General Net Theory (GNT). "General Net Theory is a strong generalization of the theory of transition nets. It was developed for the purpose of overcoming certain practical and conceptual difficulties on all levels in the computer field." (Petri 1976).

The main features of the theory are:

A (formal) principle for system composition and decomposition which works consistently on all levels of system description and system specification.

A (formal) method for introducing and emitting detail in system descriptions, accompanied by a graphical language which facilitates communication about complex structures.

symbol	interpretation	PETRI NETS	denotation
■	<u>activity</u> - action - process - information processing - data processing - program execution - event structure	TRANSITION	A_i
⬭	<u>information unit (channel)</u> <u>material unit</u> - message representating component - carrier of messages - carrier of material - communication medium - state structure	PLACE	I_i (M_i)
↑, ↓	<u>access paths</u> describe the interrelationships between the activities and the information units		
⬭	<u>compound activity</u> describes an activity of the $(n - 1)$ th level on the n -th level $(n \geq 2)$		
⬭	<u>compound information unit</u> describes an information unit of the $(n - 1)$ th level on the n -th level $(n \geq 2)$		

Fig. 17: Description of ABRAHAM

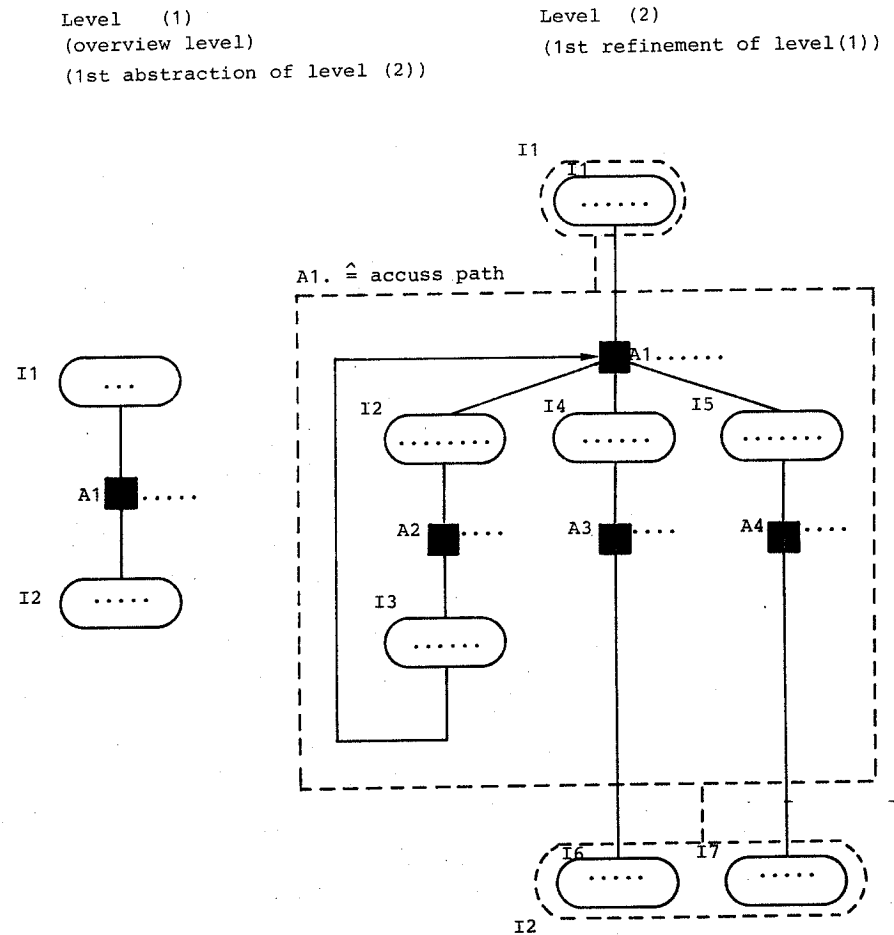

Fig.18: Example of an ABRAHAM requirement

A (formal) method for stepping through a series of conceptual levels and for defining higher-level concepts in a rigorous way on the basis of lower-level concepts.

Precision of modelling in the presence of "fuzziness" (e.g. non-transitivity of concurrency and of other similarity relations arising naturally in technical contexts).

General net theory encloses:

Formal definition of nets; basic interpretation and derived interpretations; dualities in nets; net mappings; the category of nets; net topology; net completion; synchronic structure of systems; enlogic structure of systems; fact logic in non-sequential processes and distributed systems; system properties "safe", "live", "conflict-free"; types of system components; information flow graphs.

Some remarks shall follow to get in mind the fundamentals of net theory. The purpose of net theory is not mainly descriptive but rather to supply us with descriptive, deductive and conceptual devices:

- descriptive devices for demonstrating the structure of systems and of processes supported by a system, in terms of axiomatically introduced concepts;
- deductive devices for solving application problems such as: synchronization problems, concurrency problems, problems involving mutual exclusion, conflict, arbitration, sequentialization, safety, problems of deadlock-avoidance and of endlessloop avoidance, problems in asynchronous switching logic, and last but not least, problems arising in an area, not generally known of us yet, called formal pragmatics, in which we are concerned with questions of the form 'What, precisely, do we do?', as opposed to formal semantics in which we are concerned with questions of the form 'What, precisely, does it mean';

- conceptual devices producing precise concepts on many levels or for promoting the communication between the computer expert and other people; I see this as being a main point of General Net Theory. We can communicate between ourselves very well, but it is difficult to explain computers to 'innocent' people. As a conceptual device, net theory should promote this communication and provide means for introducing new concepts, in a precise, but, nevertheless, easily visualizeable way, hence the importance of graph-theoretical methods, and of the idea of the 'token game' played by many independent actors.

Net theory is not primarily a mathematical device, rather it is accompanied by a simple graphical means of expression consisting, at the basic level, of four symbols only (see fig.19).

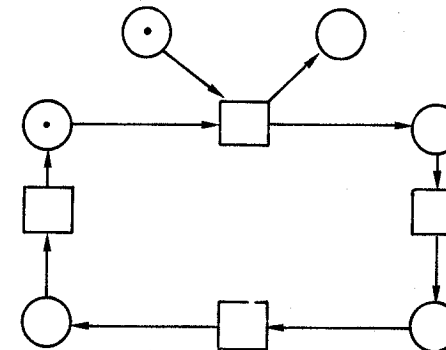

Fig. 19: Basic net structure

Thus, in this notation, we have the following four types of symbols:

S: \circ state elements (also called places if they can contain more than just one token);
S contains symbols denoting 'supply stocks', and items in these supply stocks are represented by tokens or markers (dots) on the state elements.

T: --- , transition elements, representing, for example, processes; elementary events, of which processes are built; alterations in the holdings of conditions; transportations; transformations and so on.

F: $\text{---}\rightarrow$, flow relation, no longer denoting a transition itself but only the relation between a state and a transition; F might be read 'from ... to'

• , tokens, countable items, resources of any kind.

Thus, a net is defined to be a triple (S,T,F) where

$S \cap T = \emptyset$ (state elements and transition elements are disjoint sets),

$S \cup T = \text{field (F)}$ (there are neither unconnected state elements nor transition elements)

$F \neq \emptyset$ (nets cannot be empty)

$F \subseteq S \times T \cup T \times S$ (the flow relation holds only between state elements and transition elements or vice-versa)

A marked net is a net with a distribution of tokens over the places.

The Petri net-(PN)-theory can be used to formulate a general concept of model building because of

- PN support a reasonable graphical presentation
- two kinds of elements (state and transition elements)
- PN can model sequential and concurrent processes
- PN have a mathematical theory to analyse the static and dynamic behavior

3. The Integrated Concept

3.1. Basic ideas of the new approach

To realize the integrated concept we have to close the conceptual gap between the two different methods which

- the change from informal descriptions to formal models without an explosion of the amount of representation (realized by attributes provided for the node and system relations)
- the change of anonymous 'token' to structured individuals (realized by a message address)
- the inclusion of dynamic aspects and the performance of operations on objects
- the conceptual inclusion of the "time use"
- additional "transition rules"
- the consideration of different forms of system relations.

The inclusion of dynamic aspects is realized by the flow of messages along the flow relations (arrows). Operations on messages can only be performed in the transition elements.

To include conceptually the time into the model the transition elements are provided with the time use.

To describe the dynamic of a system we introduce the "OR" relation additionally to the "AND" relation.

The processing of messages is done by the normal system relations 'INPUT' and 'OUTPUT'. The additional relation is e.g. 'COPY' to read the message without clearing.

All these additional changes and basic principles of both methods are implemented on a computer (Godbersen 1983). The next chapter shows a very simple example to demonstrate the new approach to be applied on a System Dynamics problem.

3.2 Academic demonstration example 'Retail Sector'

The integrated modified approach 'function nets' described in the previous sector is now applied to a very simple system dynamics example explained in Pugh 1976, p. 9-17.

The model will be a retail sector. The customer, who is exogenous to the model, places orders upon the retail sector for an aggregate product. These customer orders reside in a "pool" of unfilled orders until they are filled from inventory. The retail sector in turn orders to replace the items sold and to correct the inventory to the desired level, which is several weeks of average sales. These orders from the retail sector are filled after a fixed delay (Pugh 1976, p. 9). The basic structure of the model is shown in fig. 20.

The model behavior will be demonstrated, e.g. how will the actual inventory react to ten percent increase of requisitions received at retail as a function of the different delay.

In the model building process the variables 'unfilled orders' and 'actual inventory' are accumulated in the transitions. 'unfilled orders' and 'actual inventory' (see fig. 20).

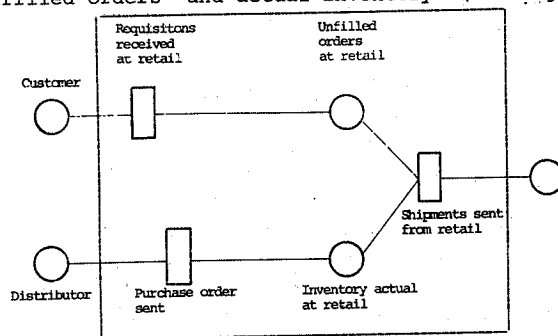

Fig. 20: Basic structure of the model 'Retail Sector'

The following operational function net is the result of the specifications of delay times, initial conditions and the policies (see fig. 21).

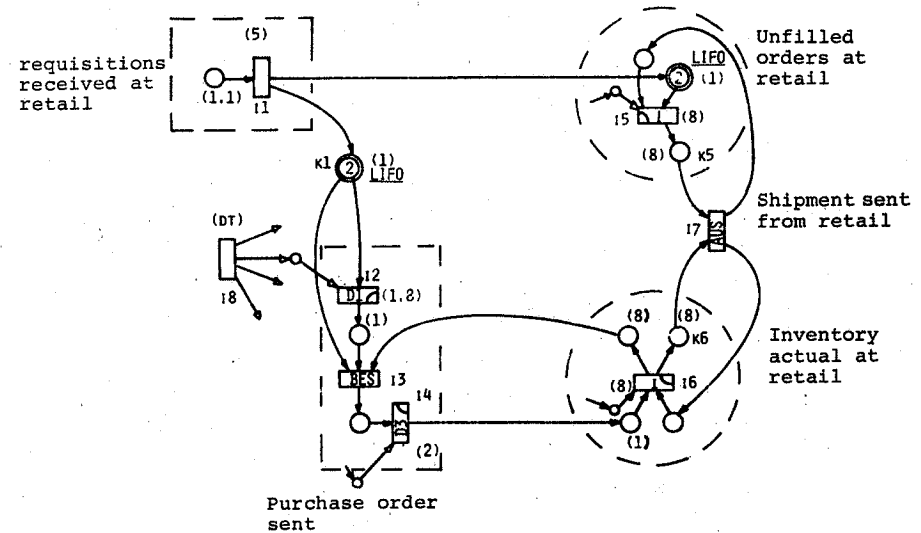

Fig. 21: Retail Sector

The accumulation of 'unfilled orders' and 'actual inventory' is realized by the INTEGRATE transition in I5 and I6. I5 gets the new orders from I1. The shipments sent from retail reduce the level of actual inventory.

The order entry (requisitions received) is constant at $RRI=1000$ (units/per week) until the fifth week, with a switch : I1 it will make a change to 1100 units. The purchase orders sent are smoothed over time in I2. I3 describes the policy for purchase order sent. Since in this simple model the distributor will be represented by a fixed third order delay of the retail order rate realized in I4. The distributor's delivery time is two weeks but can be changed in the following reruns. I8 sends to all integration and Delay transitions a start signal each time interval of DT so that all computations are performed in constant time steps. A performed analysis of validation shows that the net is without any conflicts, overall 'alive' and 'immortal'. That means there have been made no serious structural errors in the model building process. The last fig. 22 represents the Petri net of our discussed retail sector.

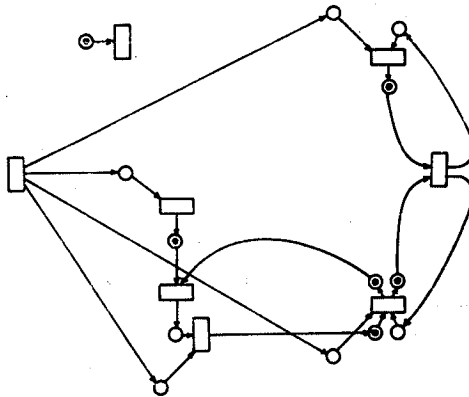

Fig. 22: Petri net of the retail sector

4. Some critical remarks

The methodological requirements in developing System Dynamics models with the explained approach 'function nets' are a lot higher than normal. But the experiences over time can help to reduce this problem. The available software tools due to all criteria of the end user have to be improved.

The approach 'function nets' allows the structural analysis of the dynamic behavior well known already of the Petri net theory. That means in the process of validation of complex models we have now an approach which has a mathematical theory for the analysis of static and dynamic behavior. This fact is an enormous progress in the area of model validation to have a tool delivering exact informations about structural errors in the model building process.

L i t e r a t u r :

1. Bonczek, R.H., Holsapple, C.W. and A.W. Winston: The Evolving Roles of Models in Decision Support Systems. In: Decision Sciences, Vol. 11/No. 2/April 1980 , p. 337-356.
2. Burger, M., Herz, H. und E. Jochem: Darstellung des technologischen Wandels durch optimale Verfahren in der Petrochemie, in: Overlapping Tendencies in Operations Research, System Theory and Cybernetics, Hrsg.: Billeter, E., Cuenod, M., Klaczko, S., Basel und Stuttgart 1976.
3. Gernert, D.: Möglichkeiten und Probleme der Integration von Daten- und Methodenbanken. In: Informatik-Fachberichte, GI-Fachtagung, Tutzing, Berlin u.a. 1979 , p. 94-109.
4. Godbersen, H.P.: Funktionsnetze; Eine Modellierungskonzeption zur Entwurfs- und Entscheidungsunterstützung. Technische Universität Berlin, Berlin, 1983.
5. Exxon Corporation: "Zur Weltenergiesituation, Blick auf das Jahr 1990", in: Öl, Zeitschrift für Mineralwirtschaft, Hrsg.: Stahmer, H., Heft 4, 1977.
6. Hauer, K.H.: Methodenbank-Monitorsysteme und ihre Einsatzmöglichkeiten. In: Informatik-Fachbericht, Berlin u.a. 1979, p. 262-273.
7. Keen, P.G.W. and G.R. Wagner: DSS: an Executive Mind Support System. In: Datamation, Nov. 1979 , p. 117-122.
8. Keen, P.G.W.: Decision Support System: Translating Analytic Techniques into Useful Tools. In: Sloan Management Review: Vol. 21/No. 3/Spring 1980 , p. 33-44.
9. Kornprobst, H. und R. Pfeiffer: Die Bedeutung neuer Technologien für die Rohstoffsituation einer Volkswirtschaft, in: Overlapping Tendencies in Operations Research, System Theory and Cybernetics, Hrsg.: Billeter, E., Cuenod, M., Klaczko, S., Basel und Stuttgart 1976.
10. Krallmann, H.: "Heuristic Optimization of Simulation Models, Represented at the Example of a Polycondensation Plant", in: Overlapping Tendencies in Operations Research, System Theory and Cybernetics, Hrsg.: E. Billeter, M. Cuénod, S. Klaczko, Basel und Stuttgart 1976.
11. Krallmann, H.: "Optimale Investitionsstrategie im Tankermarkt", zus. mit L. Nestaas; in: OR Spektrum 1, 35-50 1979a .
12. Krallmann, H.: "Integration von Input/Output-Modellen im Modellmethodenverbund - eine Anwendung zur innovativen Investitionsplanung im Maschinenbau", in: Verknüpfung sozio-ökonomischer Modelle, Hrsg.: H. Schmidt und B. Schips, Compus-Verlag, Frankfurt a.M., 1979b.
13. Krallmann, H.: "Wirtschaftlichkeitsberechnung von CAD/CAM-Systemen", in: Produktionsplanung und -steuerung im Dialog, Hrsg.: A.W. Scheer, Physica-Verlag, Würzburg - Wien, 1979c.
14. Krallmann, H.: "System Dynamics a tool for corporate Planning", in: Proceedings of the 6th. System Dynamics Conference, Paris, 1980a .
15. Krallmann, H.: "System Dynamics an efficient tool for corporate applications", in: Proceedings of the 1980 International Conference on Cybernetics & Society, Cambridge, 1980b .
16. Lundeberg, M., Goldkuhl, G. and Nilsson A.: A systematic approach to information systems development-1. Introduction, in: Information Systems, Vol. 4, 1979, p. 1-12.
17. Petri, C.A.: Concepts of Net Theory. Proceed. Symp. MFCS'73, High Tatras 1973 .
18. Petri, C.A.: General Net Theory Proceed. Joint IBM / Univ. of Newcastle Conf., {Sept.1976}.
19. Pugh, A.L.: DYNAMO-User's Manual, Fifth Edition, Cambridge, Mass. 1976 .
20. Shipping Statistics and Economics, Hrsg.: H.D. Drewry, Otd., London, Heft Juli 1977.
21. Sprague, R.H. und H.J. Watson: MIS-Concepts - Part II. In: Journal of Systems Management, Vol. 26/ No. 2 / 1975 , S. 35-40.
22. United Nations, Yearbook of International Trade Statistics, Vol. II, Trade by Commodity, Commodity Matrix Tables, New York 1975.
23. Vazsonyi, A.: Information Systems in Management Decision Support Systems. In: Interfaces, Vol. 9/ No. 1/ Nov. 1978 , S. 72-77.
24. Wagner, G.R.: Optimizing Decision Support Systems. In: Datamation/ Vol. 26/ No. 5/ May 1980 , S. 209-214.