

**"CONTINUOUS AND DISCRETE SIMULATION  
IN A PRODUCTION PLANNING SYSTEM.  
A COMPARATIVE STUDY."**

**Authors:**

Adolfo CRESPO MARQUEZ  
Rafael RUIZ USANO  
Ramón DAVID AZNAR

Depto. de Organización Industrial y Gestión de Empresas.  
Escuela Superior de Ingenieros Industriales  
UNIVERSIDAD DE SEVILLA  
41012 - SEVILLA (SPAIN)

**ABSTRACT**

In this paper a JIT/KANBAN manufacturing process is simulated using both discret event, and system dynamics methodology. The results obtained are analyzed and compared. The purpose of this research is to determine the aspects to be more conveniently studied by modeling the system with each simulation approach.

**INTRODUCTION**

The utilization of a simulation approach instead of another depends mainly (Pidd M., 84) on the following aspects:

- The developed model may be able to represent the nature of the system.
- The developed model may be adequate for the purpose of the study.

According to this, it would be interesting to compare the results obtained modeling the JIT/KANBAN production system with the system dynamics approach, to those results presented by a discret event pattern which fully reproduces the changes occurring in the system. This comparison will be accomplished for several scenarios and under financial and non-financial measurements.

Once the behaviour of the model is known, is possible to achieve conclusions concerning the system most adequate features to study with system dynamics.

## THE JIT/KANBAN SYSTEM DYNAMICS MODEL

The kanban system model described by O'Callaghan (O'Callaghan R., 86) will be the dynamic pattern considered for this comparison. A Dynamo Diagram of that model is shown in figure 1, where are depicted the last stage of production, shipment and sales.

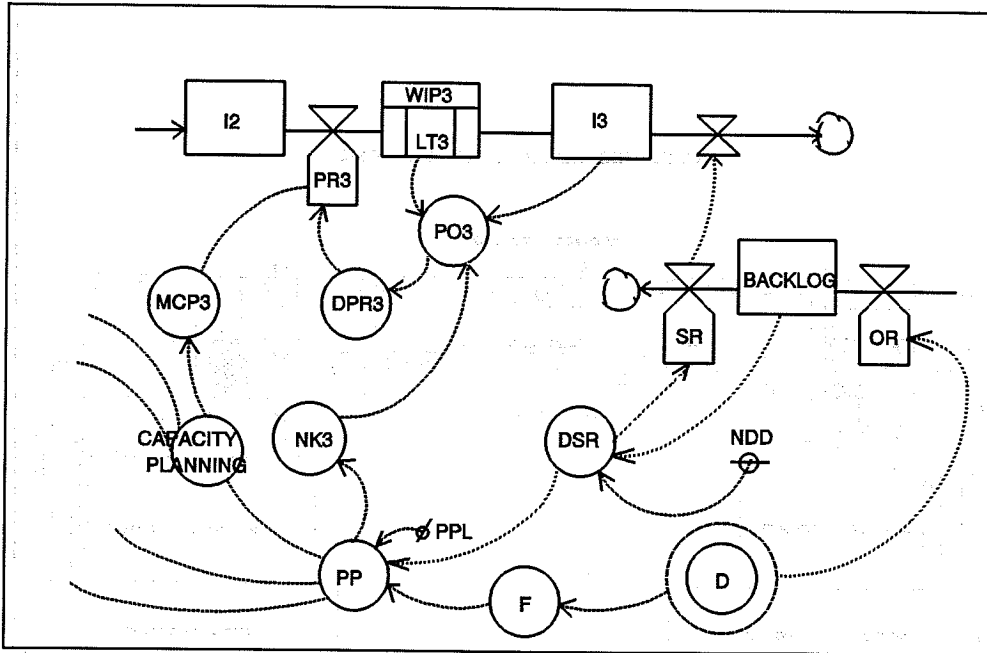
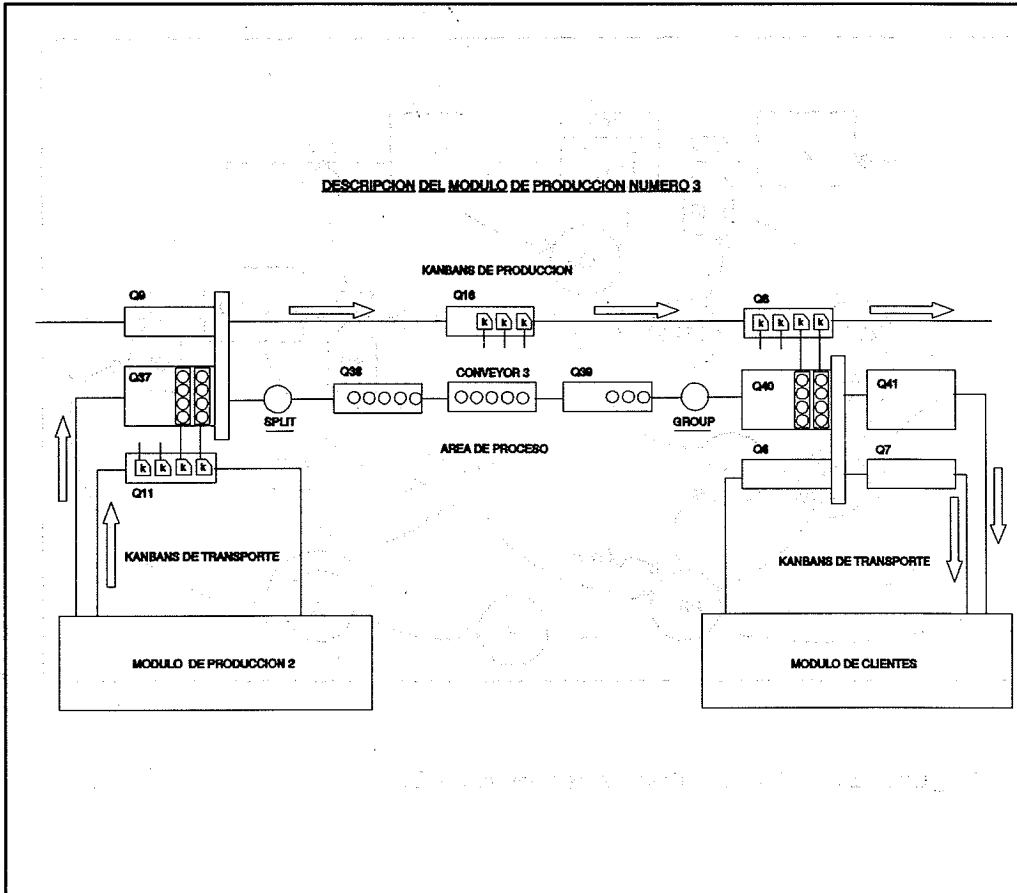

Figure 1. The kanban system model.

The model contains three in-line stages. Every stage has a lead time and a kanban cycle of 0.5 days. Originally, a maximal capacity of 120 units/day is established for every step of the process. A safety stock is considered by adding 30% more kanbans to those obtained by calculations carried out every new planning period (10 days). A new production plan is generated every planning period.

## THE JIT/KANBAN SYSTEM DISCRET EVENT MODEL

A discret event SIMAN model has been developed for this research. This pattern simulates the same manufacturing process according to a SIMAN process based discret event simulation methodology. In the following paragraphs are described some particular features of the SIMAN model.



**Figure 2.** Production stage in the SIMAN model.

The production stages are modeled using a CONVEYOR block. The kanban associated containers will arrive to queues placed before every stage of production, then a SPLIT block will separate the 10 pieces within a container and will place them in another queue where pieces are waiting to be processed.

An example of a production stage is shown in figure 2.

The CONVEYOR of every stage will take pieces one-by-one. The initial speed of the CONVEYORS gives them a 120 units/day production capacity.

Lead times and kanban cycle of every stage are 0.5 days.

The demand during the day is considered uniformly distributed (considered a demand of 100 units/day and 8 working-hours/day, there is an order arrival from customers every 4.8 minutes).

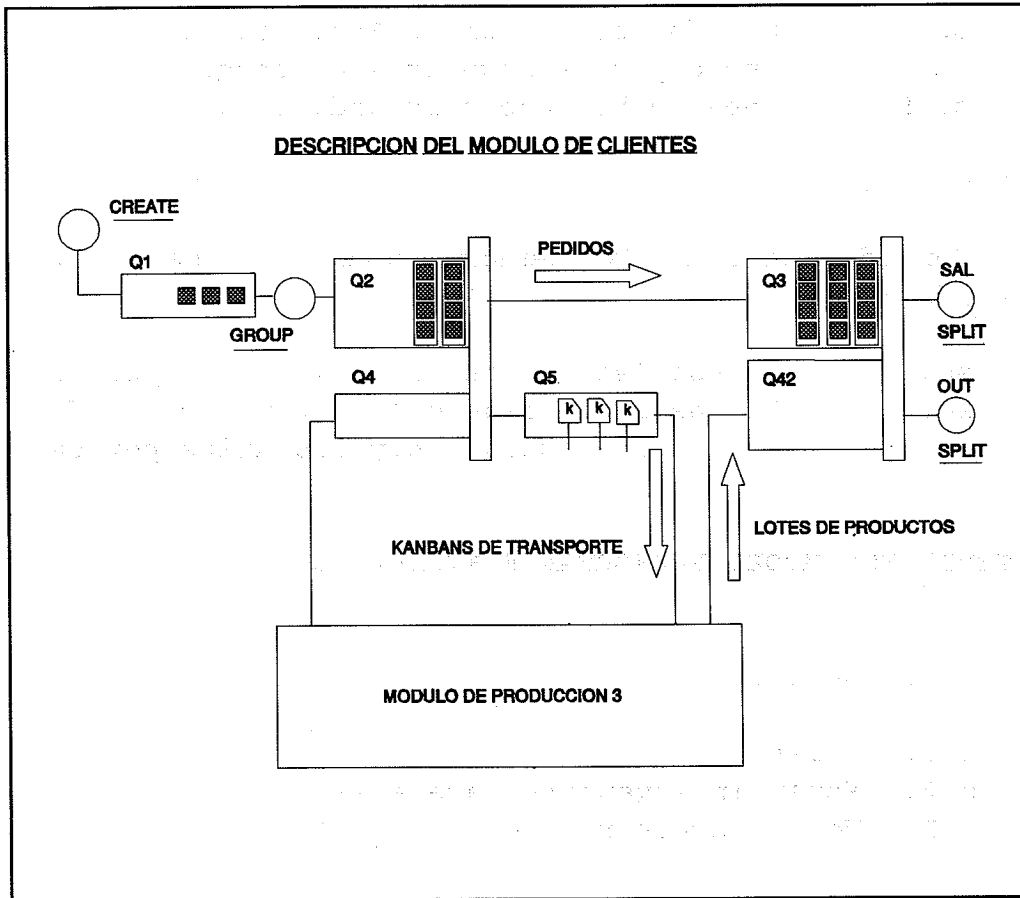

**Figure 3.** Sales in the SIMAN model.

The customer arriving orders pull production reducing final inventory. The withdrawal and production Kanbans make this effect to be reproduced in all the stages with a cycle time of 0.5 days.

## THE SCENARIOS

### Demand increase

- sc.1. Step of 10% after de 2nd. day.
- sc.2. Step of 20% after de 2nd. day.

### Breakdown in one stage

- sc.3. One-day breakdown in 1st. stage.
- sc.4. One-day breakdown in 2nd. stage.
- sc.5. One-day breakdown in 3rd. stage.

### Bottlenecks

Considering a 20 day demand increase pulse of 120 units/day:

- sc.6. In the 1st. stage only 110 units per day.
- sc.7. In the 2nd. stage only 110 units per day.
- sc.8. In the 3rd. stage only 110 units per day.

## CRITERIA FOR MODEL PERFORMANCE EVALUATION

### Financial Aspects

- c.1. Sales
- c.2. Money in inventory (average)
- c.3. Money turnover

### Non-Financial Aspects

- c.4. units in inventory (average)
- c.5. time in the system for one unit (average)

## EXPERIMENTAL RESULTS

The results obtained for each financial criteria are shown in figures 4, 5 and 6 for every scenario.

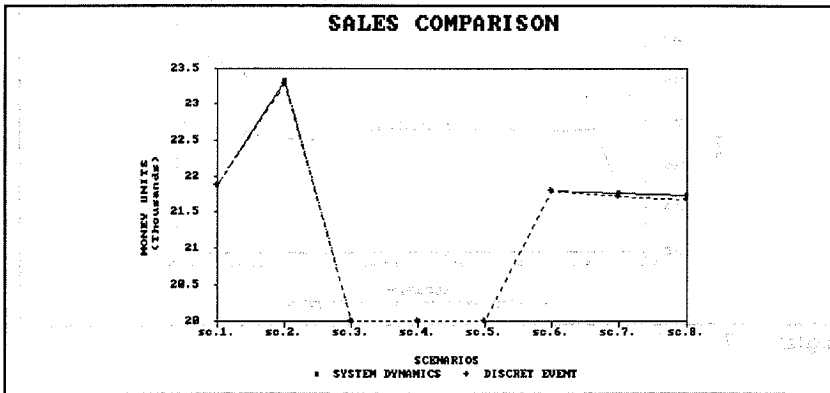

Figure 4.

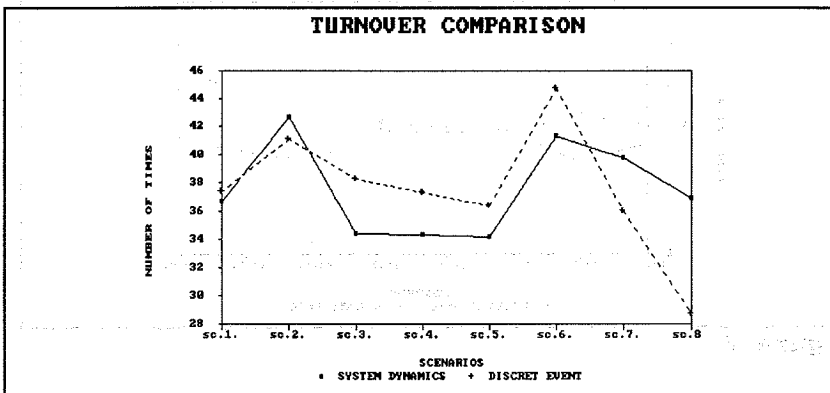

Figure 5.

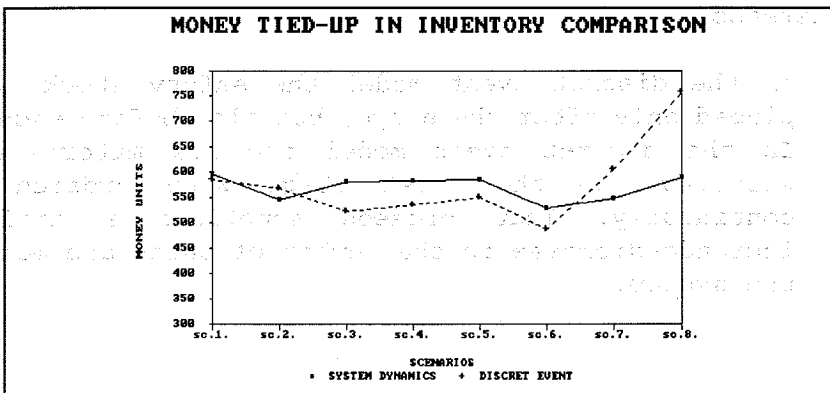

Figure 6.

The results obtained for each non-financial criteria are shown in figures 7 and 8 for every scenario.

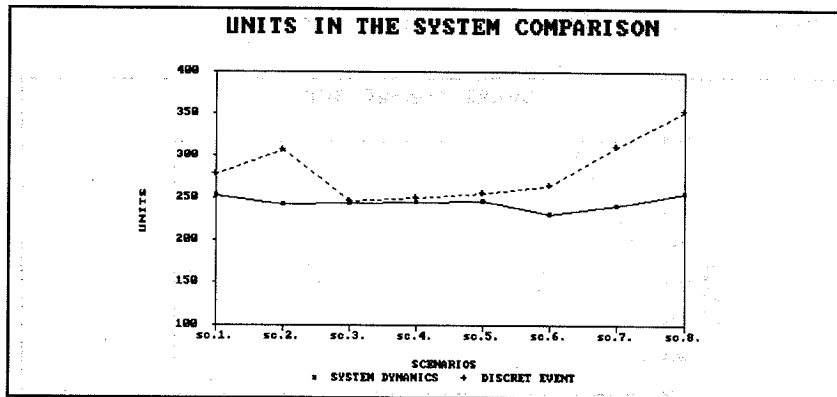

Figure 7.

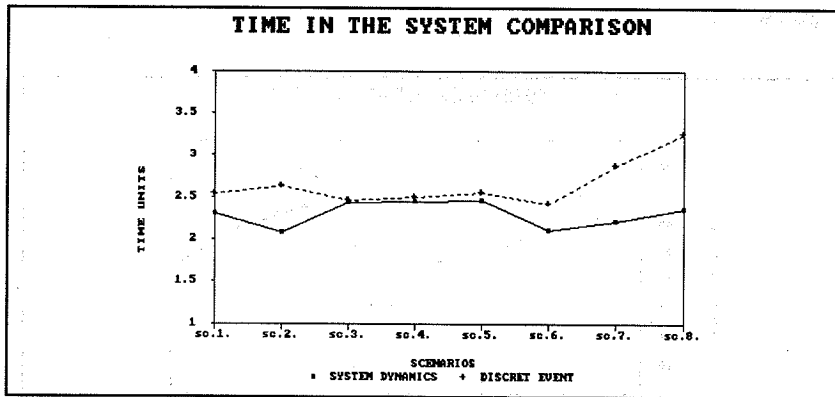

Figure 8.

To explain some of the results obtained some factors have to be understood:

- In the discret event model the safety stock is not placed only after the stage, but also before each one.
- In the discret event model the raw materials are withdrawn to the first stage when ordered, not continuously. That creates sometimes a different increase-decrease in the number of units and money in the system.

## CONCLUSIONS

The system dynamics model presents, generally, results following the trend of those obtained with the discret event pattern. System dynamics may aid in the search of solutions to production problems. A clear idea about the qualitative evolution of the system performance with particular environmental conditions can be determined. The discret event simulation methodology is more difficult to handle, but offers the best way to estimate the factory features directly related to queue phenomena (for example inventory areas), mainly when high discontinuous inputs are expected.

## BIBLIOGRAPHY

- Carry A. "Simulation of Manufacturing Systems."  
John Willey & Sons. Ltd. 1988.
- O'Callaghan R. "A System Dynamics Perspective on JIT/KANBAN."  
Proceedings of the 1986 International Conference  
of the System dynamics Society. Seville, October  
1986.
- Pidd M. "Computer Simulation in Management Science"  
John Willey & Sons. Ltd. 1984.
- Shannon R.E. "System Simulation, The Art and Science."  
Prentice-Hall. Englewood cliffs, New Jersey, 75.