

**Bipartisan process improvement in polymer coating:  
Combining system dynamics with statistical process control (SPC)**

Nicholas C. Georgantzas • Fordham University at Lincoln Center • New York, NY 10023-7471, USA  
James S. Fraser • Fordham University at Lincoln Center • New York, NY 10023-7471, USA  
Elvan Tugsuz • Fordham University at Lincoln Center • New York, NY 10023-7471, USA

**Abstract**

A firm's end-product waste problem motivated us to investigate the structure underlying a polymer coating process (PCP) by combining system dynamics simulation modeling with statistical process control (SPC). Our *bipartisan approach* proved to be rather powerful: not only it provides insight about the negative feedback-loop structure between temperature distribution and polymer thickness but also allows assessing the potential effects of leverage points on the stability of the polymer manufacturing process directly from process capability and control charts. The new knowledge gained yields a dramatic improvement in the firm's end-product quality and productivity. Worth noting is our transforming of the heat control equations—which correspond to the gelling operations of polymer foam and paste, respectively—into semidifference approximations of heat conduction that can be solved using standard Runge-Kutta methods. Consequently, our essay illustrates how to effectively handle parabolic partial differential equations using conventional system dynamics simulation software.

**Introduction**

Since the summer of 1994, we have been investigating the polymer coating process of PCP, a firm competing in the global industry of polymer web processing. With a workforce of ninety, the firm's manufacturing facility employs a rather sophisticated polymer foam and paste coating process. Its polymer leather products are marketed to manufacturers of a whole range of consumer goods, including apparel and accessories. Despite the potentially huge global market for artificial leather products, however, the firm has remained rather small in its fledging industry, partly because of its far from glamorous performance in end-product quality and productivity. End-product thickness variation has been causing much waste in output, ranging from 25 to 30 percent.

The manufacturing manager and engineers who work on the coating line agreed to participate in a system dynamics modeling project to better understand how the management system structure of the foam and paste coating process might be causing the undesirable behavior observed in end-product thickness. Initial discussions culminated into tangible output: a system dynamics simulation model of the polymer coating process. The model allows tracking changes in the firm's coating line configuration, in terms of

- (a) the gelling temperature distribution of foam and paste, and
- (b) the polymer foam, paste and lining thickness.

The project investigates the firm's end-product waste problem by combining system dynamics simulation modeling with statistical process control (SPC) tools.

Fig. 1  
Coating line configuration.

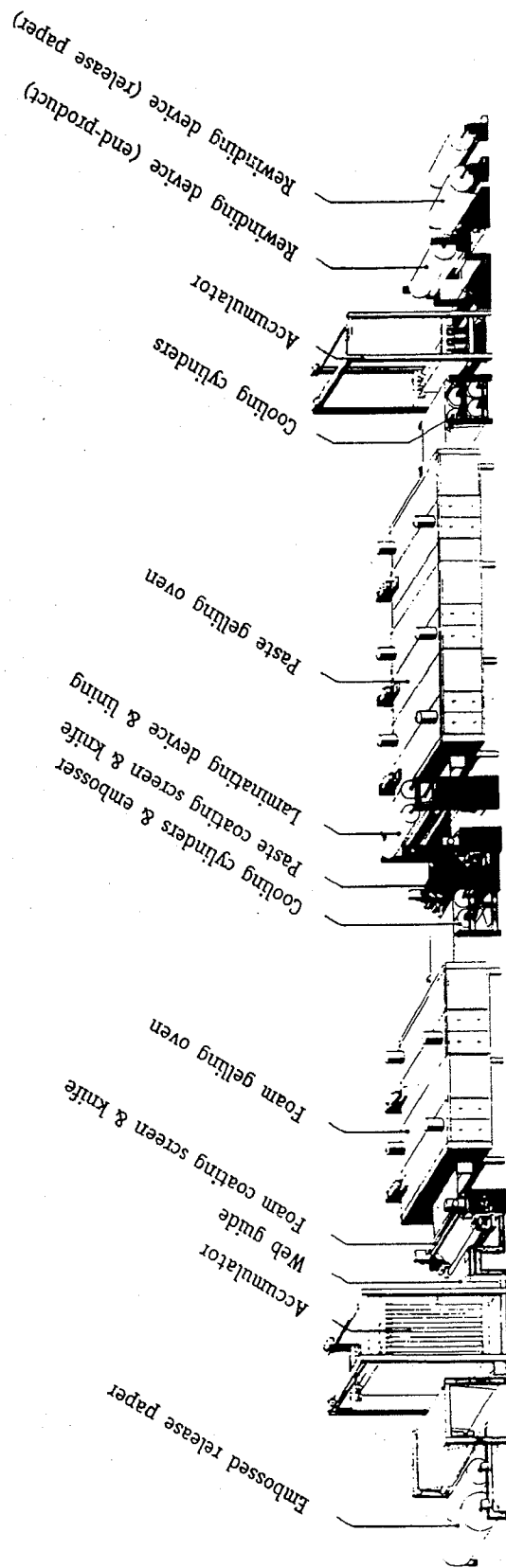

This 'bipartisan approach' is powerful for not only it provides insight about the negative feedback-loop structure between temperature distribution and material thickness, but also allows assessing the potential effects of leverage points on the stability of the polymer manufacturing process directly from process capability and control charts. The new knowledge gained warrants a dramatic improvement in the firm's end-product quality and productivity.

Worth noting in this research is the transformation of heat control equations—which correspond to the gelling processes of foam, and paste, respectively—into semidifference approximations of heat conduction that can be solved using a standard Runge-Kutta numerical method. Consequently, the essay illustrates how to effectively handle parabolic partial differential equations of the form

$$\frac{\partial k}{\partial x} \frac{\partial T(x,t)}{\partial x} = \rho c \frac{\partial T(x,t)}{\partial x} \quad (\text{Nakamura, 1991; Tadmor \& Gogos, 1979})$$

using conventional system dynamics simulation software.

### Model Construction

Although improving quality—and thereby productivity (Deming, 1993)—is a prudent goal for any firm, the true value added of the project lies in the benefit of personal improvement through system dynamics simulation modeling. The real model the CPC project participants worked on is the model of themselves. The modeling process forced clear thinking about PCP's coating line process.

Building a model for PCP's coating line configuration (Fig. 1) required first of all a clear definition of every part of the process, which by itself is both useful and educational. In addition, by repeated simulations, a better understanding of the process is achieved, greatly improving the insight and developing the *engineering intuition* of the project participants. Armed with our system dynamics model, PCP's quality and productivity problems are studied, the effect of individual variables isolated, and sensitivity and stability problems explored. All these are hard, costly, or virtually impossible to carry out in the real production process.

The objective of the quality and productivity improvement project is to reduce the end-product waste of PCP. During the investigation, PCP's president and CEO, as well as the production manager, engineers and supervisory personnel of PCP were invited to participate in the modeling process, and to contribute their own understanding of how the coating line configuration actually works. This gave them the opportunity to challenge their engineering intuition about quality improvement options.

To achieve these objectives, the project incorporated a mix of

- (a) prebuilt system dynamics models;
- (b) deterministic and stochastic simulation experiments, in order to
  - capture participant knowledge about PCP's coating line,
  - stimulate critical thinking among participants, and
  - invite project and model ownership by participants; and
- (c) statistical process control (SPC) charts.

Combining system dynamics simulation models with statistical process control (SPC) tools helped the participants gain more knowledge about PCP's sophisticated coating process. The insight gained from the project warrants the desired

Fig. 2  
Tracking end-product thickness  
through the coating line  
configuration.

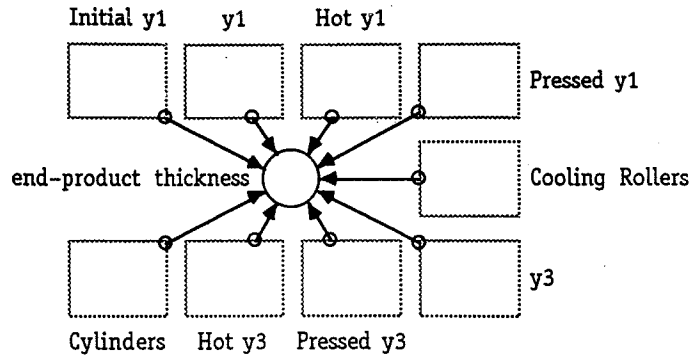

y1 = foam thickness  
y2 = foam + paste thickness  
y3 = foam + paste + lining thickness

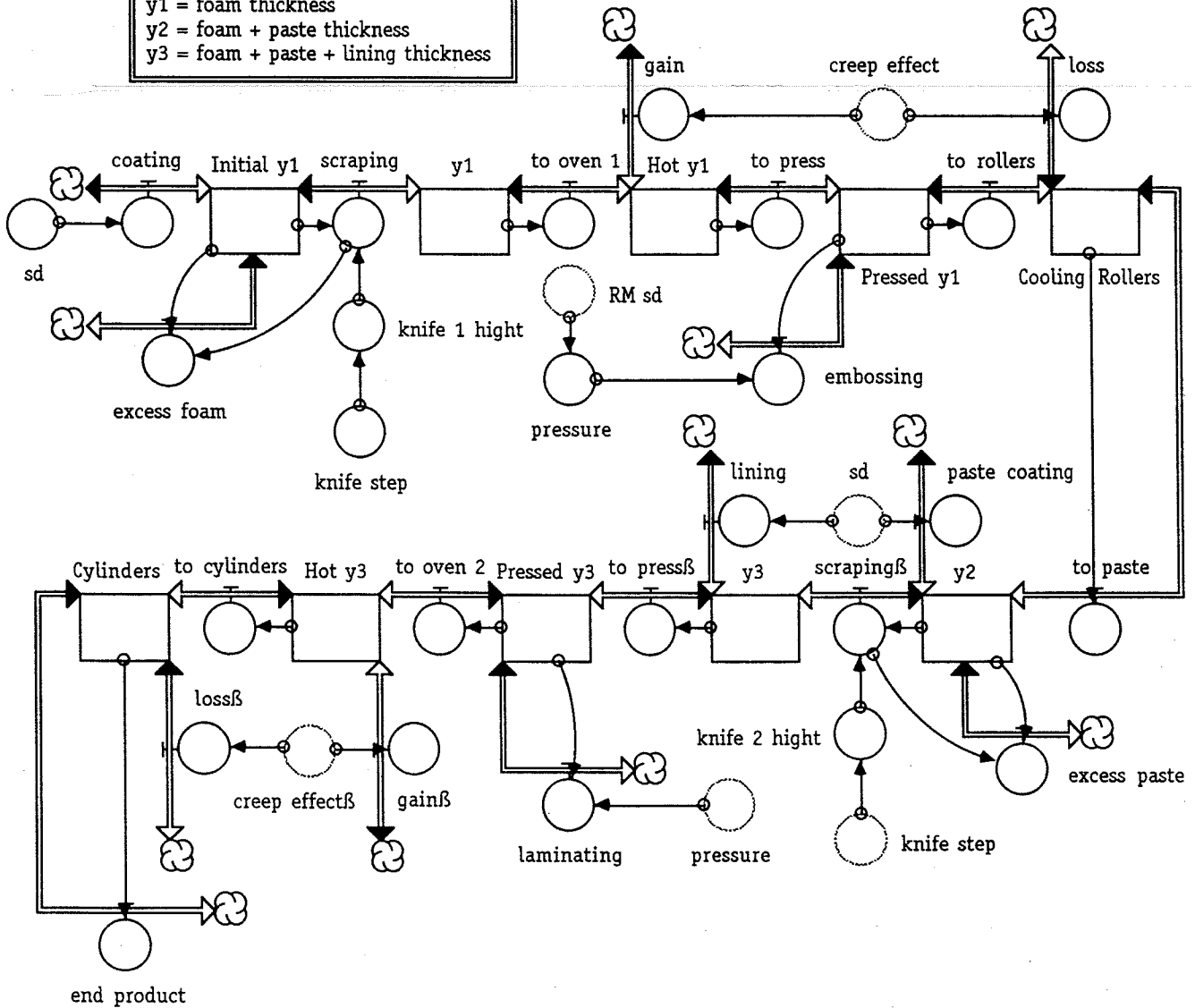

## Parallel Program

**Fig. 3**  
 The semidifference approximation for the space- and time-dependent thermal conductivity exploits the negative feedback loop between thickness and temperature.

( a ) Foam temperature

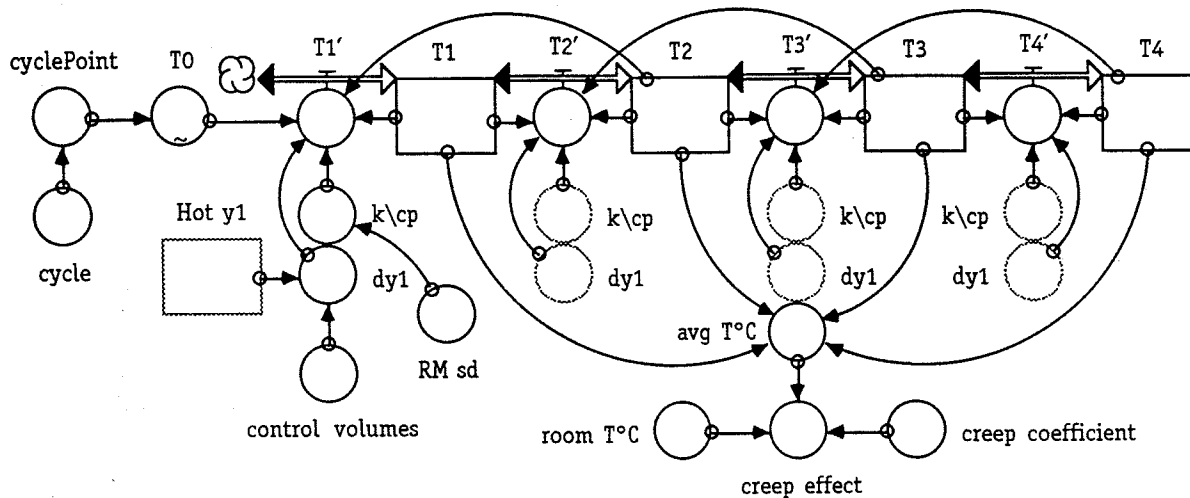

( b ) Paste and foam temperature

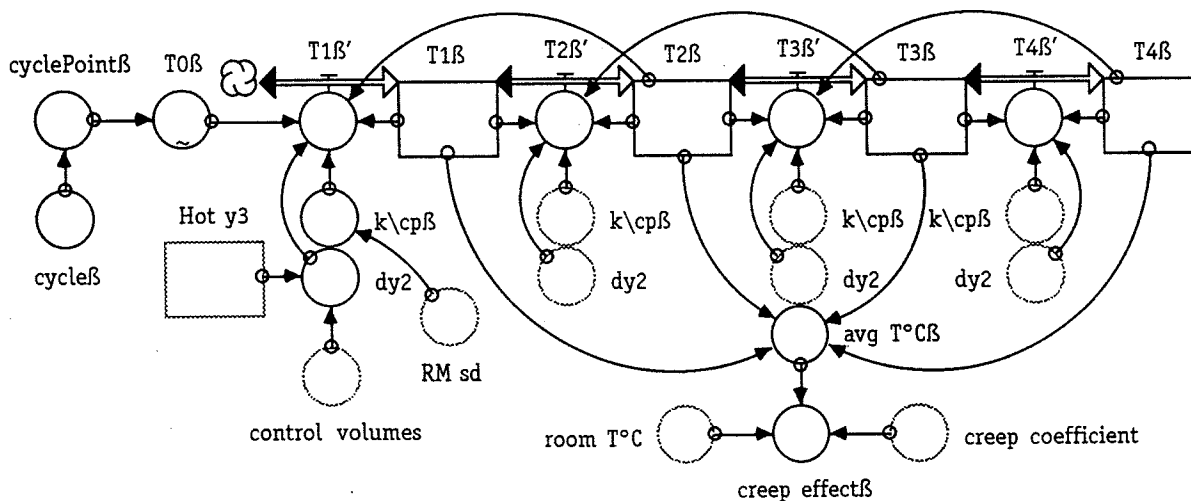

( c ) Relationship between thickness and temperature

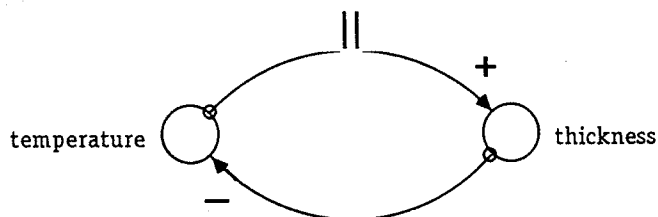

improvement of PCP's end-product quality and productivity. The more PCP participants felt that they own the model and the simulation results, the more eager they became to implement the changes recommended by the model and the simulation results. Alternatively put, PCP's end-product waste is reduced, and its production quality and productivity improve, only because the project participants are now convinced that their intuition about improvement options is compatible with the changes recommended by the model and the simulation results.

### Model Structure

A fundamental difference between simulation modeling and other problem solving methods lies in the source of the data. In simulation models, data are gathered from a computer model as opposed to being gathered in the real world. The simulation modeling project described here emphasized parameter estimation and simulation of modified models which begun as simple open-loop models and increased in complexity as new feedback loops were added to represent the real production constraints of PCP's polymer coating line (Fig. 1).

Figure 2 and Fig. 3 show the system dynamics model which the PCP project participants helped to build. The model tracks the polymer foam and paste thickness throughout PCP's actual coating line of Fig. 1. As originally anticipated, the project run for a period of seven months, with two model revisions before a final report was submitted to PCP with definite recommendations for quality and productivity improvements.

The lower part of Fig. 2 details all the changes that occur in the material from the initial polymer foam coating and scraping to polymer paste coating and lining to the cooling cylinders and end-product output and inspection. The small diagram on the top of Fig. 2 allows tracking the end-product thickness—the major quality management concern and metric during this project.

Figure 3a and Fig. 3b detail the semidifference approximation used for the space- and time-dependent thermal conductivity of the polymer foam and paste, respectively, which exploits the negative feedback loop between polymer thickness and temperature of Fig. 3c. The higher the polymer temperature, the thicker the foam and paste will gradually become but, the rate of change in their temperature distribution will also be gradually annihilated by their thickness.

### Model Behavior

Once several prebuilt system dynamics models were revised, and the participants' input captured and mapped, a set of simulation experiments followed, like those in Fig. 4 and Fig. 5. The objective of each experiment was to challenge intuition about quality and productivity improvement options at PCP's polymer coating process.

The project also incorporated SPC *control charts* (Fig. 6). Statistical process control can assess whether or not quality problems exist in production. Control charts either suggest that corrective action is needed to improve quality or give assurance that a process is producing satisfactory quality. Using data from the computer model, the control charts of Fig. 6 were constructed for (a) the range and (b) the mean of end-product thickness. Ten samples of size  $n=10$  were gathered from the model of Fig. 2 and Fig. 3, with random variation ( $sd =$  standard deviation) on in coating thickness as well as in raw material (RM). The range and mean values that

Parallel Program

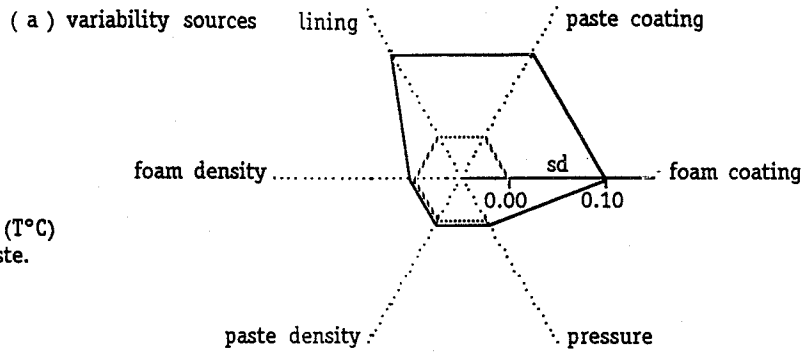
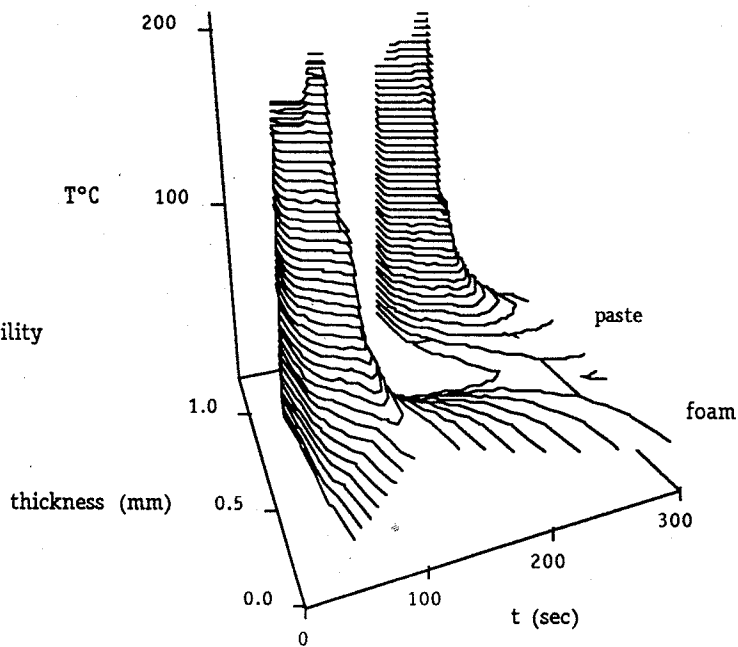

Fig. 4  
The effect of variability (sd)  
on the gelling temperature ( $T^{\circ}\text{C}$ )  
distribution of foam and paste.

( b ) without variability



( c ) with variability

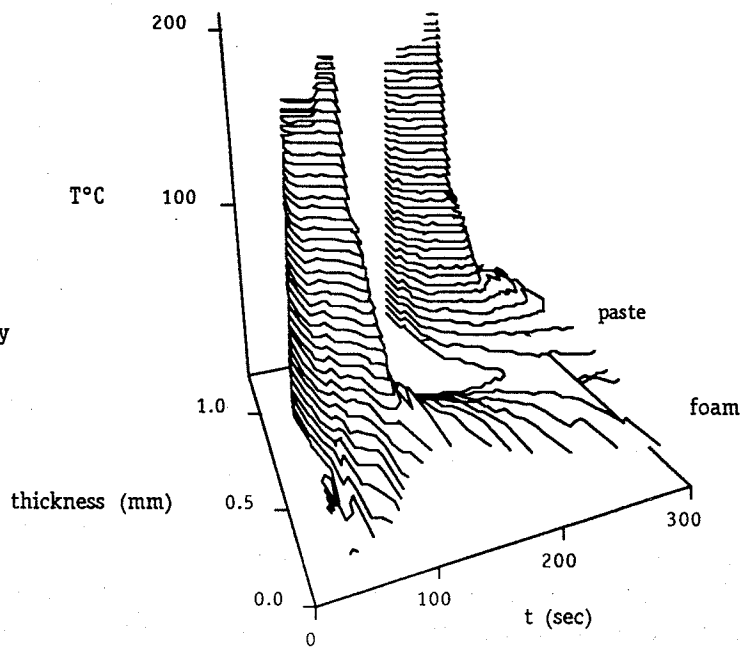
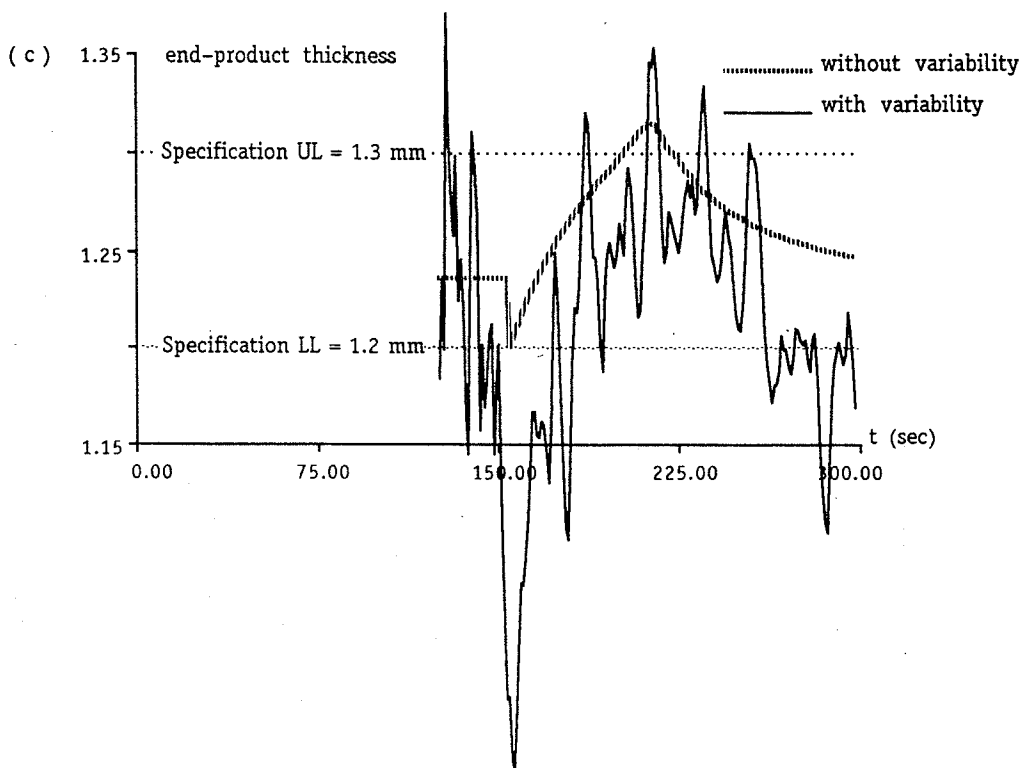
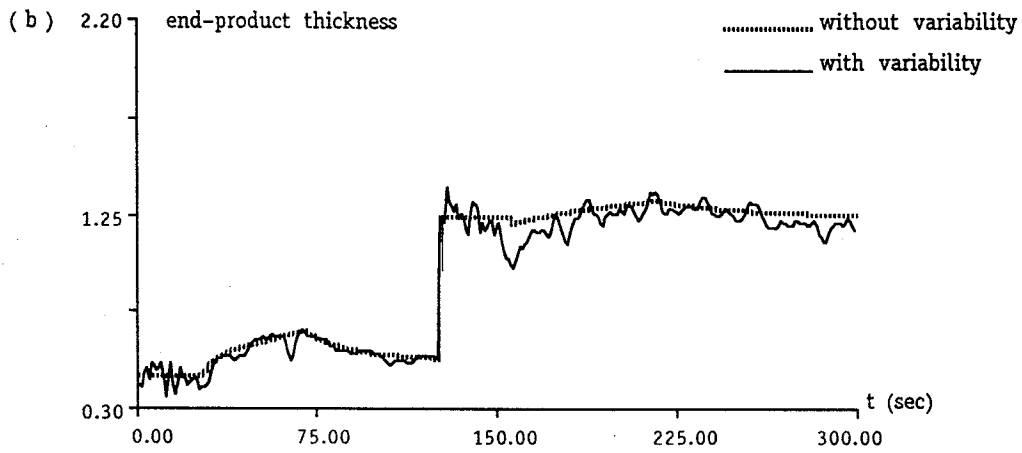
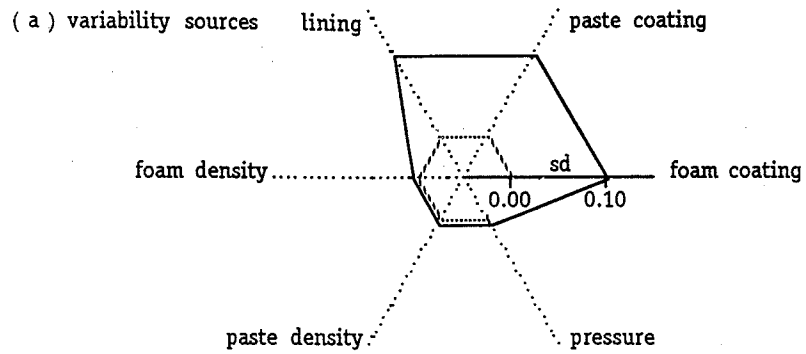

Fig. 5  
The effect of variability (sd) on end-product thickness.





## Parallel Program

---

Fig. 6  
Statistical process control (SPC) charts  
given the end-product specifications  
(10 samples of size  $n = 10$ ).

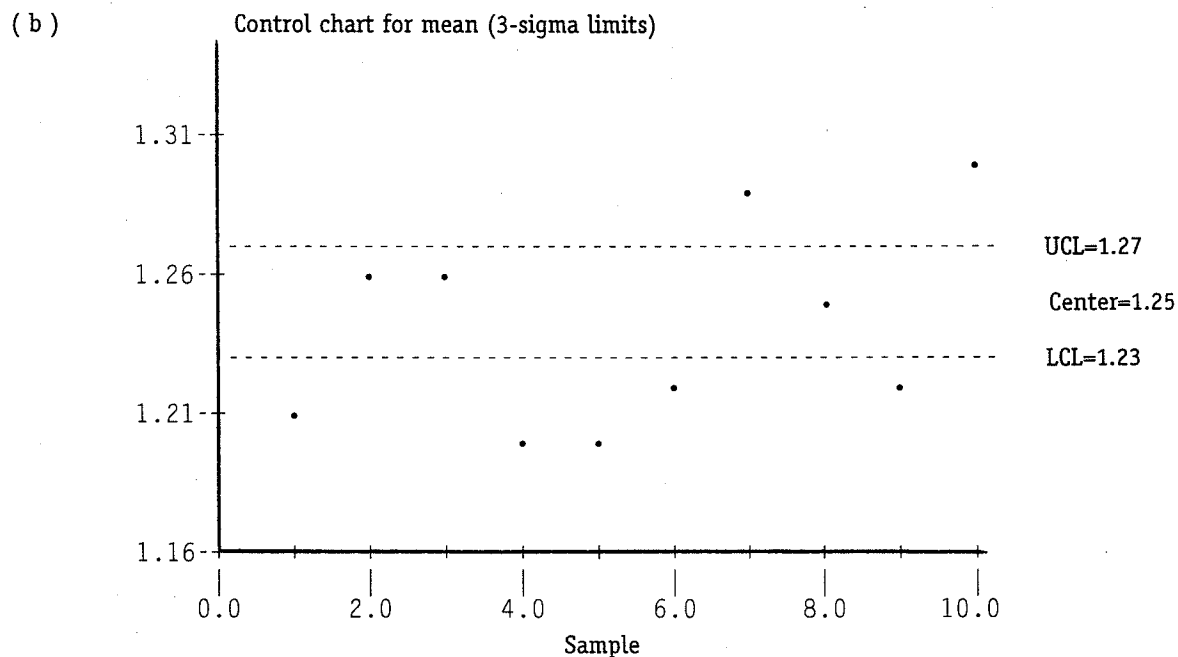
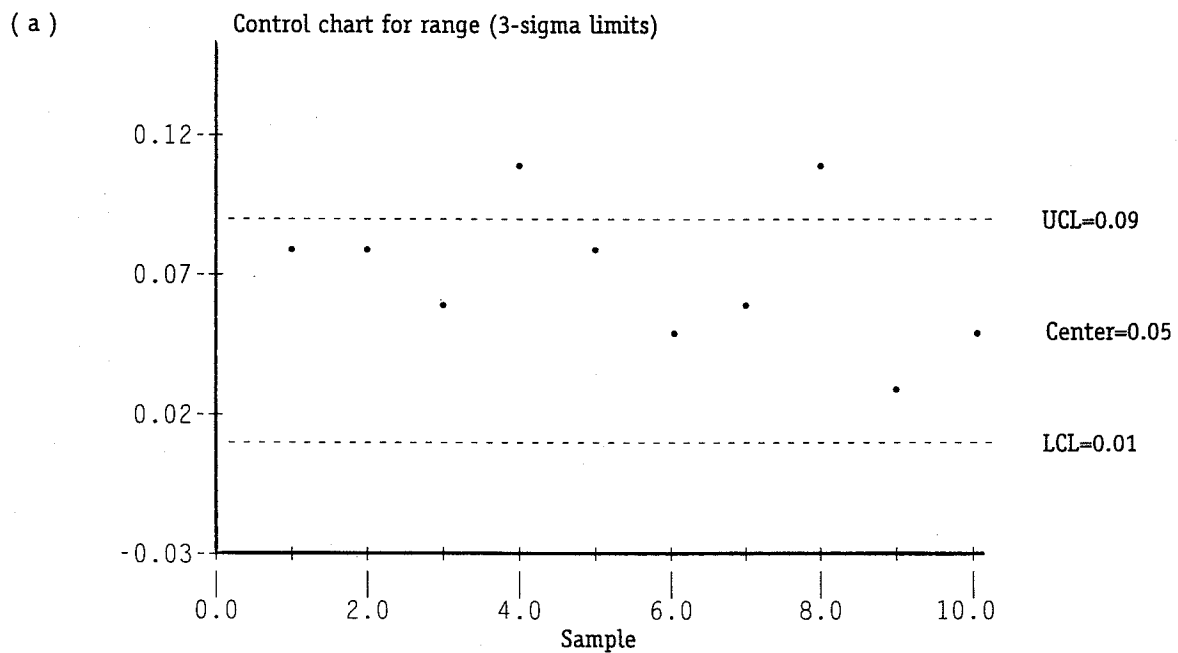

fall above the *upper control limit* (UCL) or below the *lower control limit* (LCL) show how PCP's polymer coating process gets out of control. Therefore, corrective action was required to reduce the variability that produced these values.

This recommendation, which is consistent with the *process capability chart* of Fig. 5c, shows the type of recommendation that should be anticipated throughout a bipartisan process improvement that combines system dynamics with statistical process control (SPC). Upon completion of the project, a final report was submitted to document the investigation, with specific and concrete action recommendations for quality and productivity improvement in PCP's coating line.

### Conclusion

In the last thirty years, the computer evolution has turn simulation modeling into a prelude to organizational learning. Engaging in simulation modeling for learning now helps PCP compete by creating new knowledge about the system structure of its production process. Creating this new knowledge will require capturing aspects of this structure that may be neither easy to observe nor easy to measure. The proposed project will use the system dynamics methodology to simulation modeling because of the broad yet coherent structure for modeling this methodology provides (Forrester, 1961).

The more PCP participants felt that they own the model and the simulation results, the more eager they became to implement the changes recommended by the model and the simulation results. Alternatively put, PCP's end-product waste is reduced, and its production quality and productivity improve, only because the project participants are now convinced that their intuition about improvement options is compatible with the changes recommended by the model and the simulation results.

Together, the project team and the PCP participants bring together a unique combination of skills and knowledge that is a prerequisite for effective modeling. On the one hand, the PCP participants have already shown that they can provide a solid base of operating knowledge, including factory knowledge of PCP's manufacturing process, and industry knowledge of the technology used in PCP's production. The system dynamics model of Fig. 2 and Fig. 3, as well as the attached simulation results, could not have been created without their timely and effective cooperation.

### References

- Deming, W.E. (1993). *The New Economics*. Cambridge, MA: MIT/CAES.
- Forrester, J.W. (1961). *Industrial Dynamics*. Cambridge, MA: MIT Press.
- Nakamura, S. (1991). *Applied Numerical Methods with Software*. Englewood Cliffs, NJ: Prentice Hall.
- Tadmor, Z. & Gogos, C.G. (1979). *Principles of Polymer Processing*. New York, NY: Wiley.